



UNIVERSITÀ  
DEGLI STUDI  
FIRENZE  
Scuola di  
Architettura



INTERNATIONAL COURSE ON  
ARCHITECTURAL DESIGN

Environmental Design Course  
Prof. G. Ridolfi, PhD

# THE BUILDING ENVELOPE

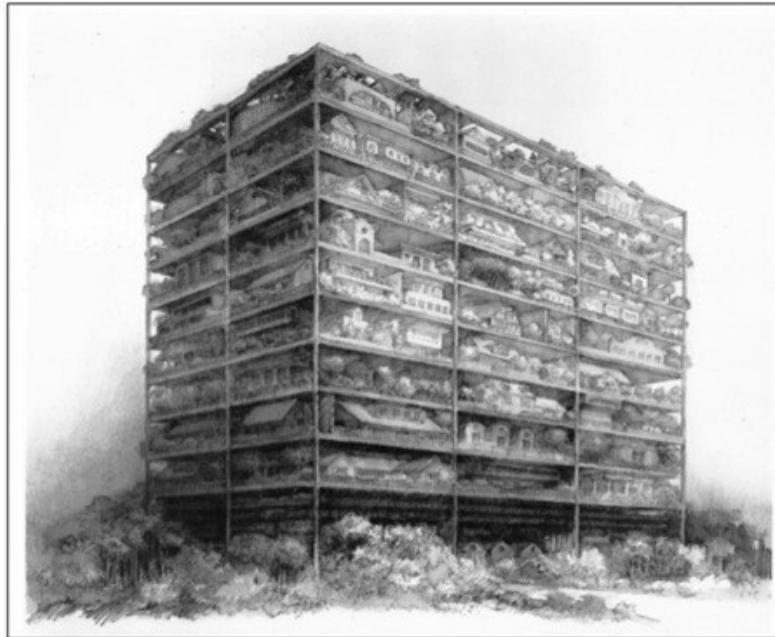




UNIVERSITÀ  
DEGLI STUDI  
FIRENZE  
Scuola di  
Architettura

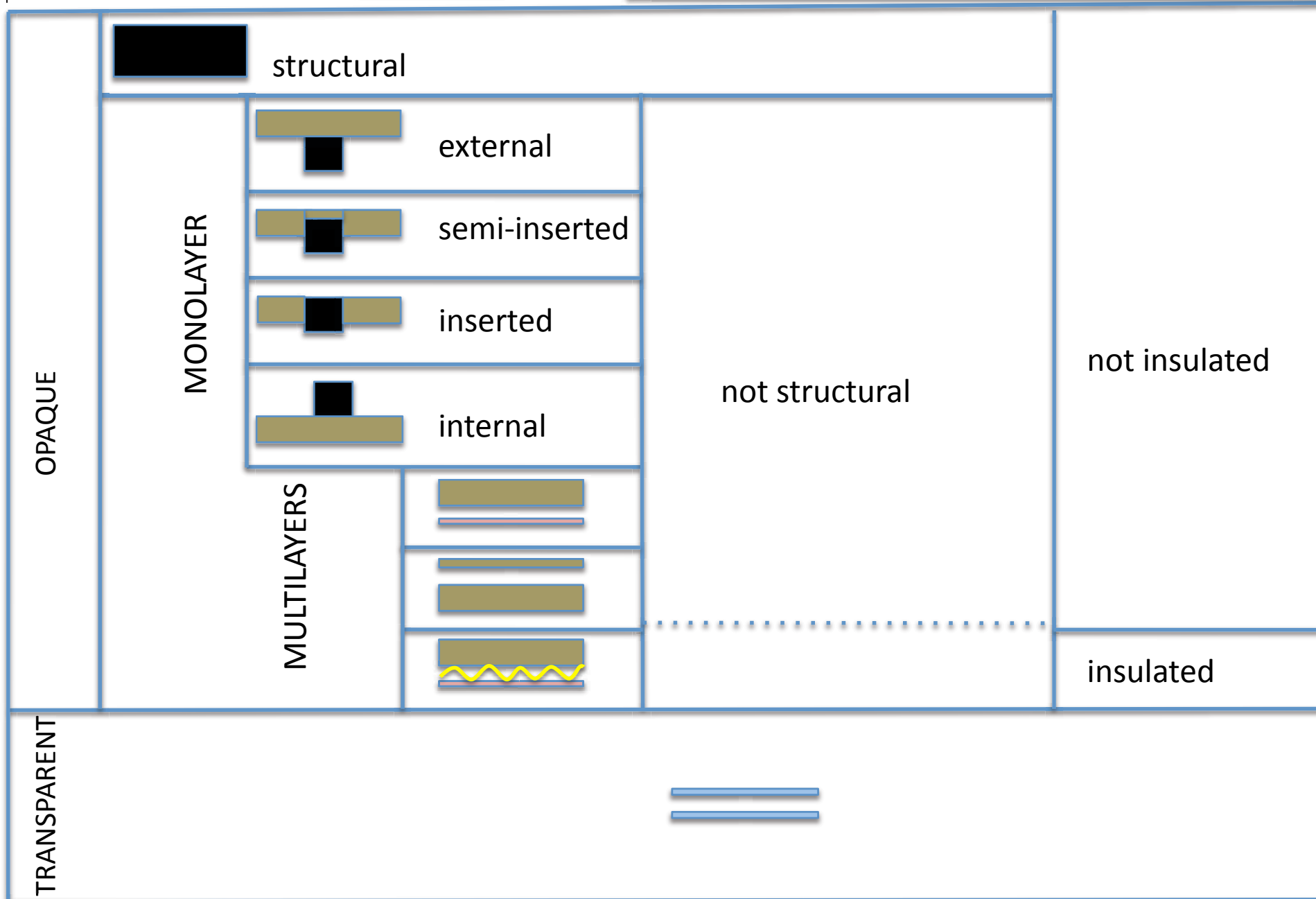


INTERNATIONAL COURSE ON  
ARCHITECTURAL DESIGN



**Highrise of Homes** – James Wines & SITE – Theoretical proposal for USA cities – Architecture - 1981

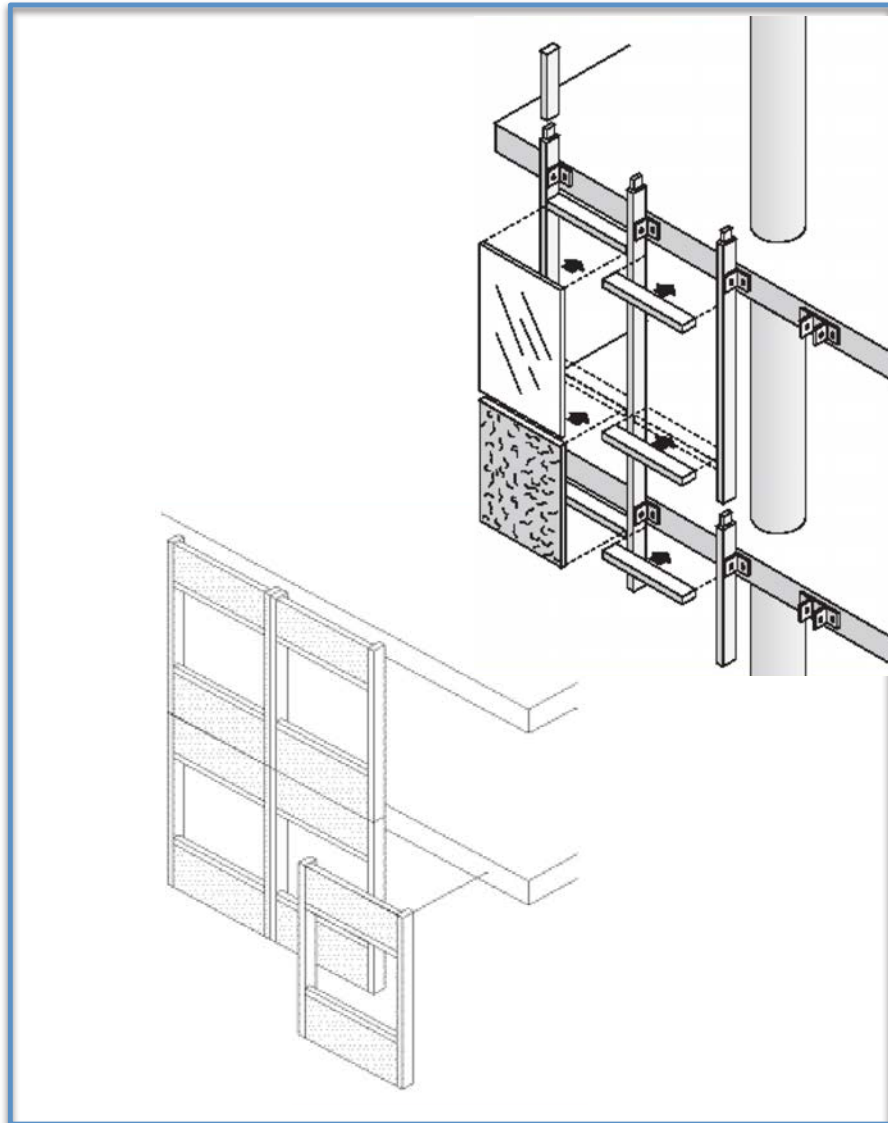
# BUILDING ENVELOPE TYPOLOGIES



... SCREENED / NOT SCREENED; HEAVY/LIGHT; ADAPTIVE/NOT ADAPTIVE; MONOCOQUE/....

# ENVELOPE RETROFIT STRATEGIES

1. removing and replacing of the existing walls with a higher performance solution

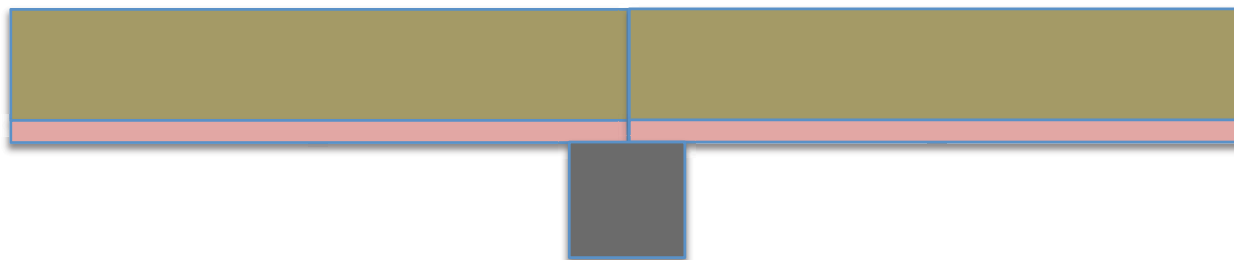


2. Integrating the existing envelope

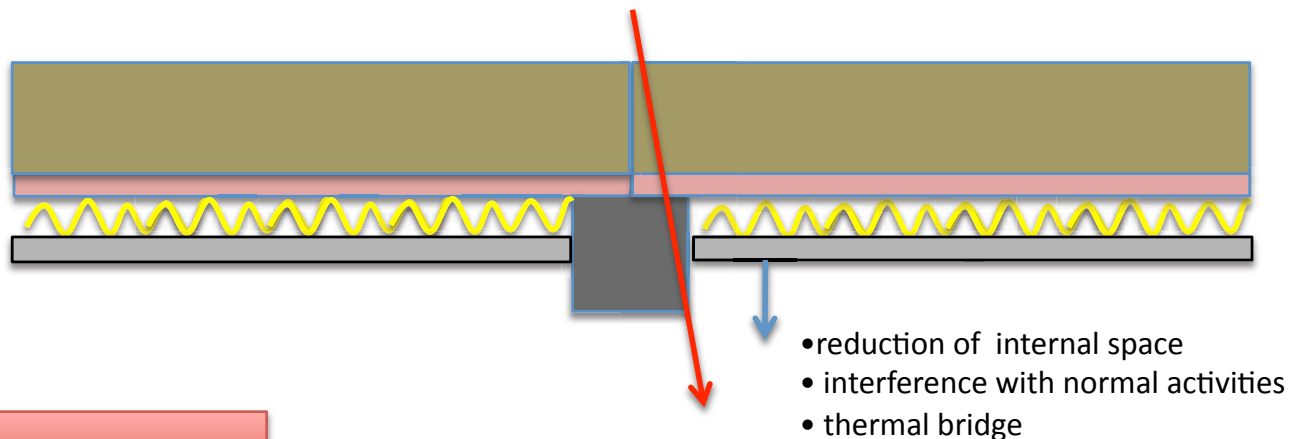
- EXTERNAL INSULATION
- VENTILATED CLADDING
- DOUBLE SKIN
- + SCREENING
- + ADAPTIVE

# INTEGRATING THE EXISTING FAÇADE

Current situation

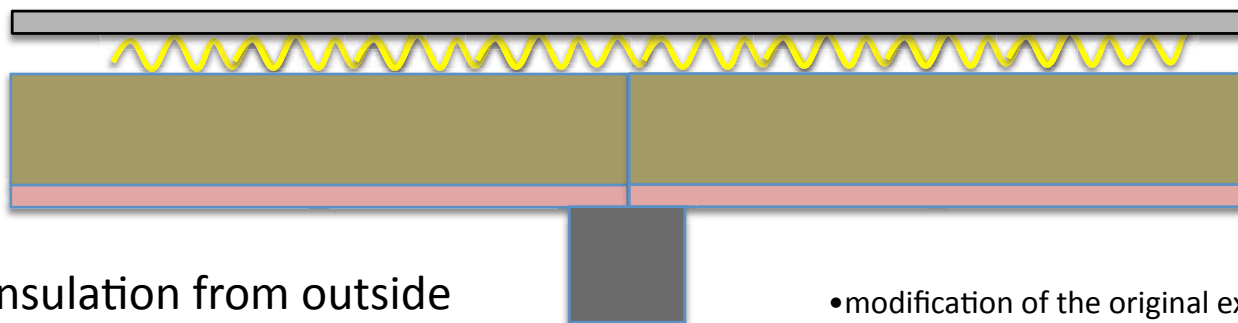


Insulation from inside



## EXTERNAL INSULATION

Insulation from outside



- modification of the original external aspect

# THERMAL PROPERTIES

CONDUCTIVITY  $\lambda$  (DENSITY)  $\gg$  RESISTANCE =  $1 / \lambda$

Table A1 Thermal conductivity of some common building materials		
Material	Density (kg/m <sup>3</sup> )	Thermal Conductivity (W/mK)
<b>General Building Materials</b>		
Clay brickwork (outer leaf)	1,700	0.77
Clay brickwork (inner leaf)	1,700	0.56
Concrete block (heavyweight)	2,000	1.33
Concrete block (medium weight)	1,400	0.57
Concrete block (autoclaved aerated)	700	0.20
Concrete block (autoclaved aerated)	500	0.15
Concrete block (hollow)	1800	0.835
Cast concrete, high density	2,400	2.00
Cast concrete, medium density	1,800	1.15
Aerated concrete slab	500	0.16
Concrete screed	1,200	0.41
Reinforced concrete (1% steel)	2,300	2.30
Reinforced concrete (2% steel)	2,400	2.50
Wall ties, stainless steel	7,900	17.00
Wall ties, galvanised steel	7,800	50.00
Mortar (protected)	1,750	0.88
Mortar (exposed)	1,750	0.94
External rendering (cement sand)	1,800	1.00
Plaster (gypsum lightweight)	600	0.18
Plaster (gypsum)	1,200	0.43
Plasterboard	900	0.25
Natural slate	2,500	2.20
Concrete tiles	2,100	1.50
Clay tiles	2,000	1.00
Fibre cement slates	1,800	0.45
Ceramic/Porcelain tiles	2,300	1.30
Plastic tiles	1,000	0.20
Asphalt	2,100	0.70
Felt bitumen layers	1,100	0.23
Timber, softwood	500	0.13
Timber, hardwood	700	0.18
Wood wool slab	500	0.10
Wood-based panels (plywood, chipboard, etc.)	500	0.13

*Note:*  
The values in this table are indicative only. Certified values, should be used in preference, if available.

# THERMAL PROPERTIES

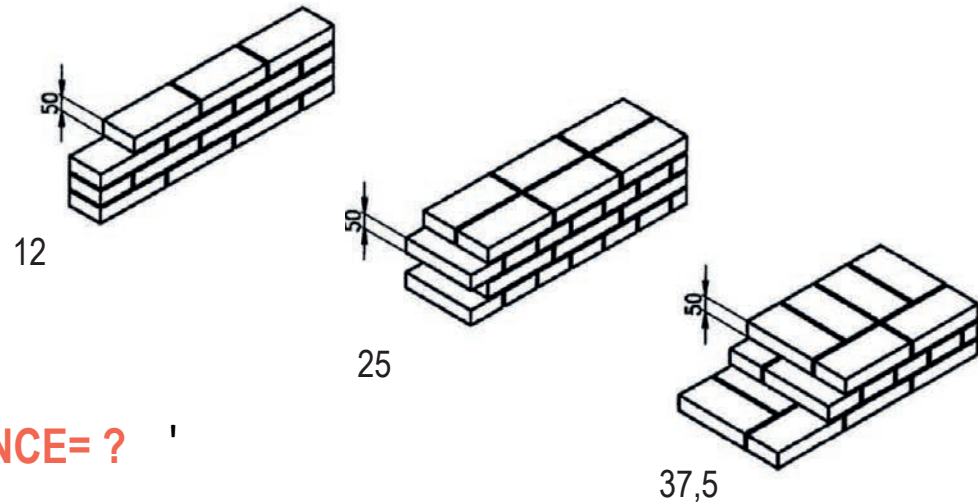
CONDUCTIVITY f(DENSITY) >>> RESISTANCE= 1 / CONDUCTIVITY

## PROPERTY OF AIR AS INSULATION

using porosity and discontinuity

### WALL OF CLAY BRICK

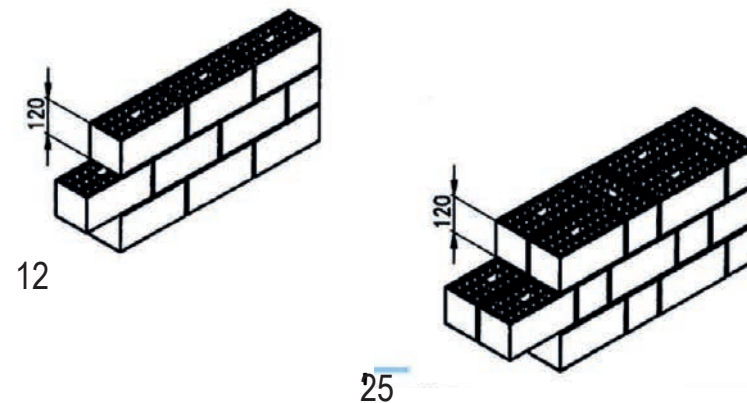
CONDUCTIVITY 0,77 W/MK



THERMAL RESISTANCE= ?

### WALL OF HOLLOW CLAY BLOCK

CONDUCTIVITY 0,56 W/MK



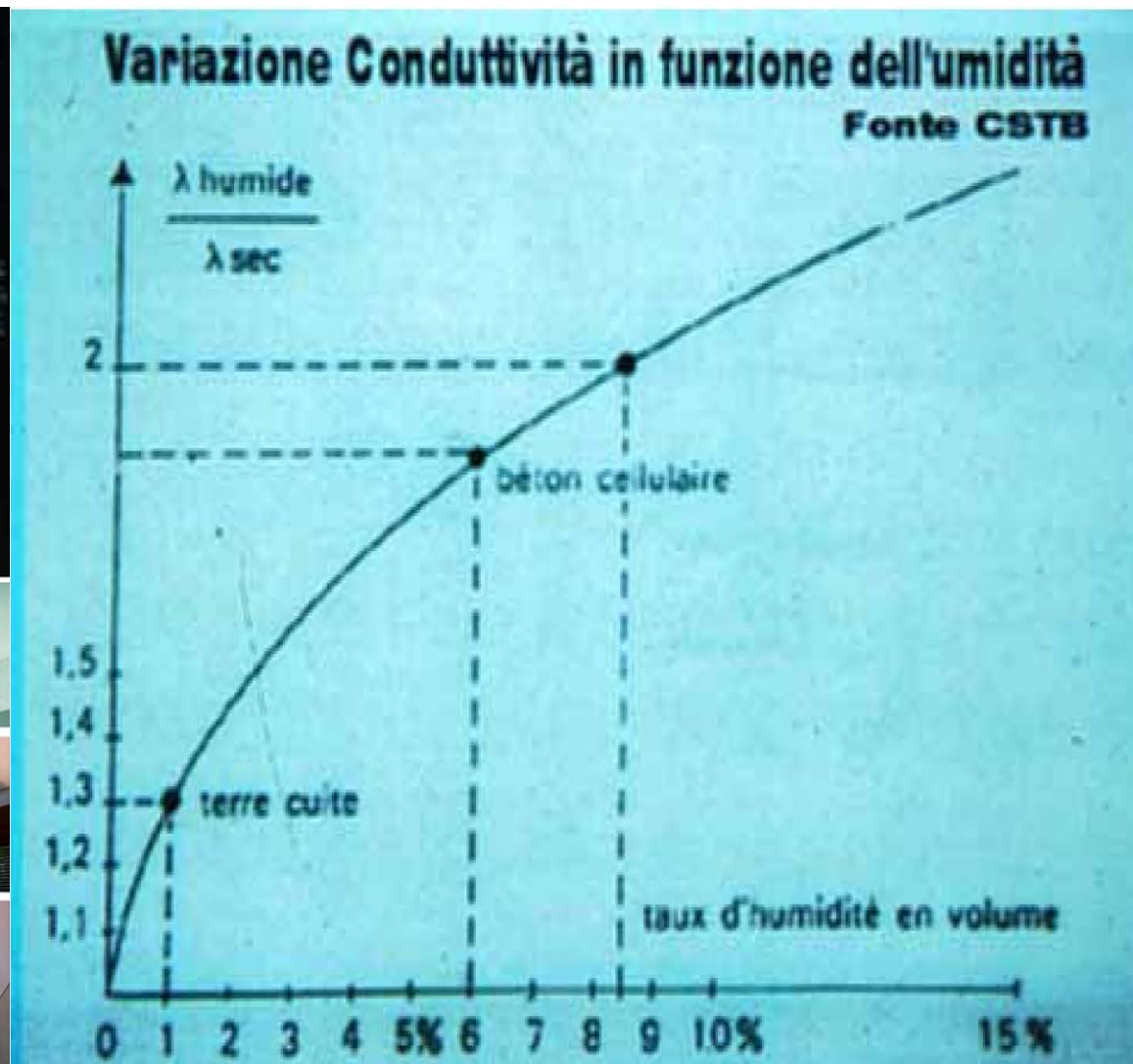
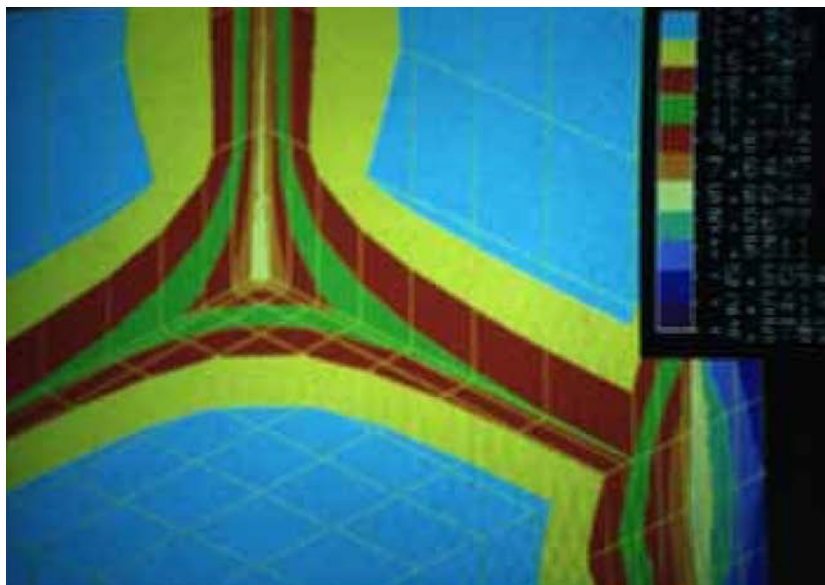
# THERMAL PROPERTIES OF AIR

RESISTANCE OF NON VENTILATED AIR (M<sup>2</sup>K/W)

Spessore dell'intercapedine d'aria (mm)	Direzione del flusso termico		
	Ascendente	Orizzontale	Discendente
0	0,00	0,00	0,00
5	0,11	0,11	0,11
7	0,13	0,13	0,13
10	0,15	0,15	0,15
15	0,16	0,17	0,17
25	0,16	0,18	0,19
50	0,16	0,18	0,21
100	0,16	0,18	0,22
300	0,16	0,18	0,23



## REDUCTION OF INSULATION PROPERTY DUE TO HUMIDITY





PLASTER & FOAM



RIGID PANELS



MATTS



LOOSE MATERIALS

## Conventional Insulation

EXPANDED PLASTICS (polystyrene, poliuretano (silicon-calcium- urea formaldeide))

MINERAL FIBERS (fiber glass, mineral wool)

Conventional and include: fiberglass mineral wool, polystyrene, polyurethane foam, and multi-foils. These materials are widely used because not only are they inexpensive to buy and install, but there is an assumption from the building industry that their performance ability is higher than the natural alternatives. On the downside, almost all conventional insulation materials contain a wide range of chemical fire retardants, adhesives and other additives, and the embodied energy in the manufacturing process is very high.

## Natural Insulation

EXPANDED ROCKS

CLAY

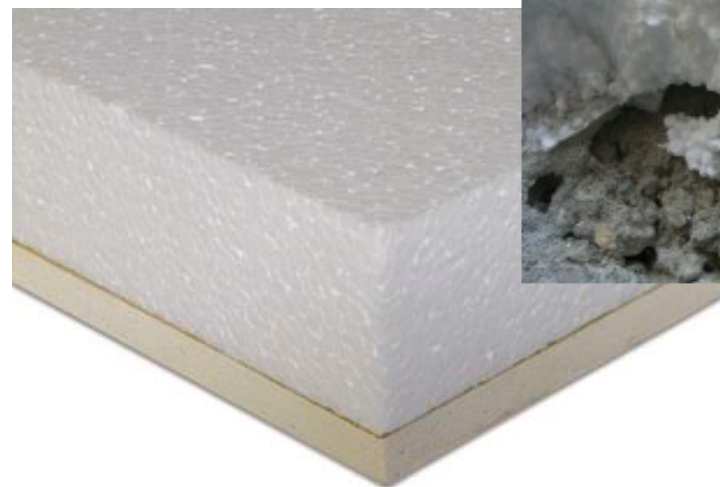
CELLULAR CEMENTS (silicon-calcium)

NATURAL FIBERS (wool-cotton-cellulose and other wood derived)

They are non-toxic, allergen-free and can be safely handled and installed. They also allow for a buildings to breathe by regulating humidity through their absorbent properties, and reducing problems of condensation. This keeps the indoor environment comfortable and protects any timber structures from rot.

Unfortunately, natural insulation materials are currently up to 3 times more expensive than conventional materials, which can be prohibitive to builders, architects and developers.

## Insulation from petrochemicals



Effect of moisture in EPS

*Polystyrene usually called polystyrol*

### **Polyurethane or Stiferite**

*Over time, R-value decreases steadily. Is susceptible to moisture infiltration*

Not only is polystyrene in walk-ins made with recycled materials and is 100% recyclable but it is energy efficient and can save a great deal of money in energy costs and reduce carbon footprint over the life-cycle of the walk-in.

### **Extruded Polystyrene (XPS)**

*Over time, R-value decreases minimally*

### **Sintered Expanded Polystyrene (EPS)**

*Over time, R-value decreases. Is susceptible to moisture infiltration*



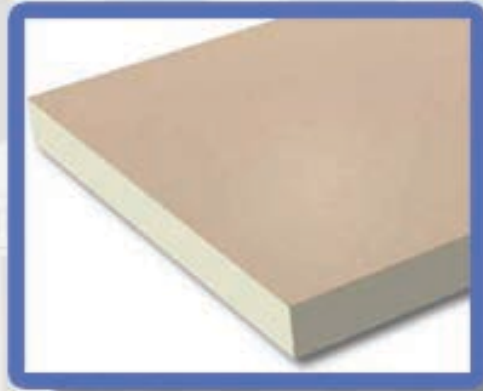
**Extruded Polystyrene vs EPS has**

- more density,
- around 5 times insulation properties
- higher mechanical resistance

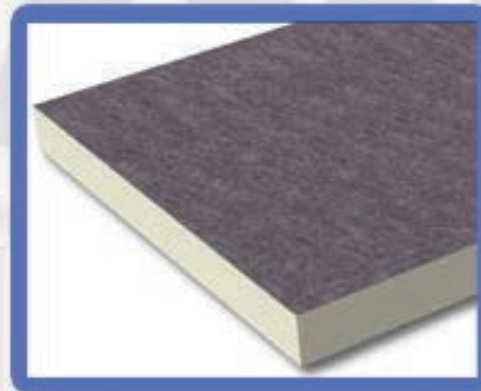
# INSULATION MATERIALS

Different density for different applications: CLASS OF APPLICATION (POLYURETHANE FOAM OR STIFERITE)

GT



Class B



Class SK



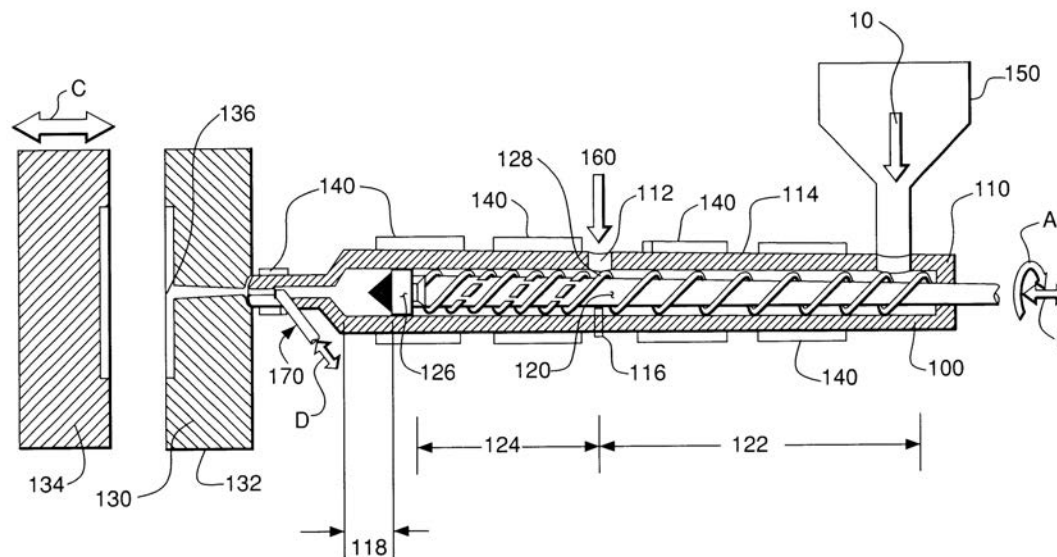
## Pannelli Stiferite

- Applicazioni GT: Isolamento di coperture, pavimenti e pareti
- Applicazioni Class G: Isolamento sotto manti bituminosi
- Applicazioni Class SK: Isolamento di pareti a cappotto

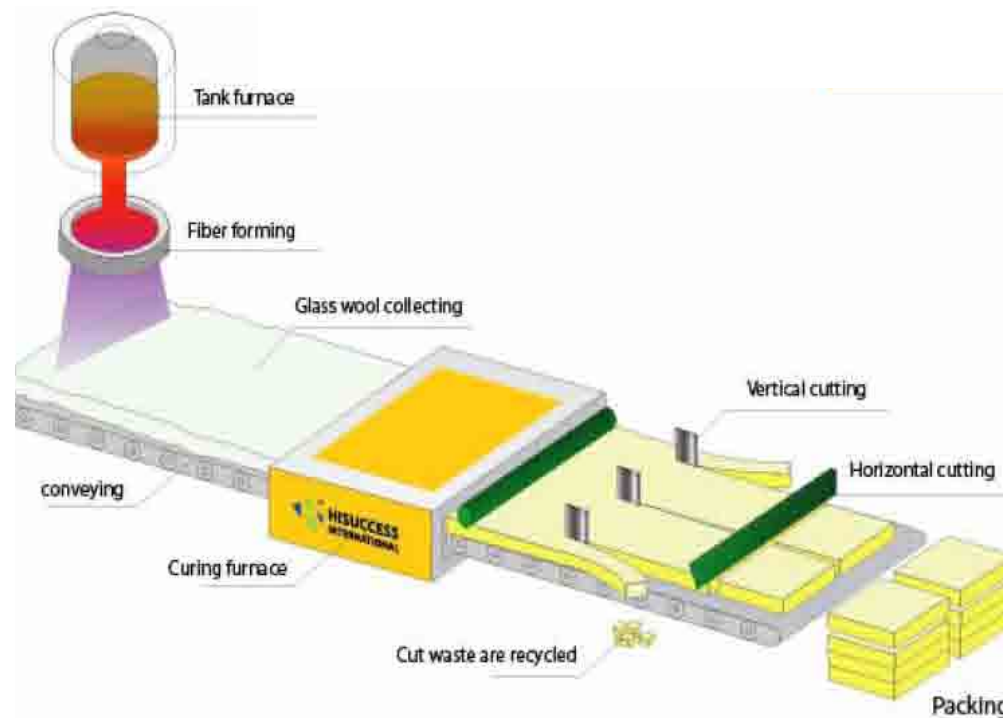
**stiferite**<sup>®</sup>  
l'isolante termico



SINTERIZATION PROCESS  
(higher density)



EXTRUSION PROCESS



# INSULATION MATERIALS

FIBERGLASS

MINERALWOLLA



# INSULATION MATERIALS



## CELLULOSE

### Cellulose

A recycled product made from newsprint and other cellulose fibre. It is one of the most favoured materials of natural builders because it can be blown into cavity walls, floors and roofs or used as a loose fill. Also it is available in quilts, boards and batts. Like hemp and flax it contains borate as an additive. Products include: Warmcell and Ecocel.



## WOODFIBRE

### Wood Fibre

Made from wood chips that have been compressed into boards or batts using water or natural resins as a binder. It has very low embodied energy and uses by-products from the forestry industry. Examples include: Pavatex, Thermowall and Homatherm



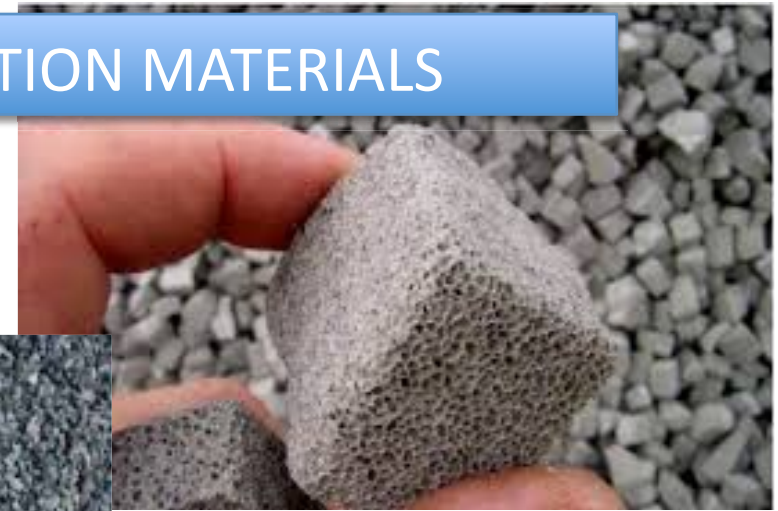


# INSULATION MATERIALS

LIMECLAY



PERLITE

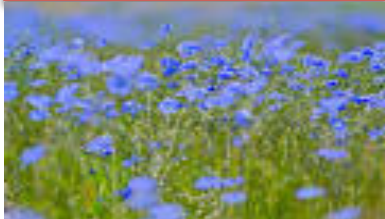


## Expanded Clay Aggregate

These are small fired clay pellets that expand at very high temperatures to become lightweight, porous and weight-bearing. They can be used in foundations as both an insulator and aggregate. They have excellent thermal insulation properties, but high embodied energy.

## GREEN INSULATION

### FLAX



### HEMP



### STRAW



### CORK



### SHEEP WOOL



The green alternative to synthetic insulation is natural insulation. There are many different types available, including:

#### Flax and Hemp

Natural plant fibers that are available in bats and rolls, and typically contain borates that act as a fungicide, insecticide and fire retardant. Potato starch is added to flax as a binder. Both materials have low embodied energy and are often combined in the same product. Examples include Isonat and Flax 100.

#### Flax and Hemp

It is obtained from the cork oak (*Quercus Suber L*) – a forest tree with the particular feature of allowing itself to be stripped of the outer casing which it then regenerates in 9 to 10 years. In one cubic inch in size, there are approximately 200 million of minute cells, each separated by an impermeable and remarkably strong, resinous membrane (more than 50% of the volume is air). This cellular structure makes cork light in weight, buoyant, resistant to the penetration of moisture, compressible, resilient, resistant to the effects of friction and an ideal thermal and sound insulation material. In addition, cork is much more chemically inert than most materials, and is therefore capable of withstanding deterioration through age. Cork does not support its own combustion and chars only slowly when subjected to a flame. Unlike some synthetic insulation materials, in burning it does not produce chlorides, cyanides or other toxic gases.

#### Sheep's Wool

This material usually needs to be treated with chemicals to prevent mite infestation and reduce fire risk, although some natural builders use it untreated with success. It has very low embodied energy (unless it is imported) and performs exceptionally well as an insulation material. Thermafleecce is the most common commercial brand available.





UNIVERSITA'  
DEGLI STUDI  
FIRENZE  
Scuola di  
Architettura

**iCAD**

INTERNATIONAL COURSE ON  
ARCHITECTURAL DESIGN

# INSULATION MATERIALS





UNIVERSITÀ  
DEGLI STUDI  
FIRENZE  
Scuola di  
Architettura



INTERNATIONAL COURSE ON  
ARCHITECTURAL DESIGN

# INSULATION MATERIALS



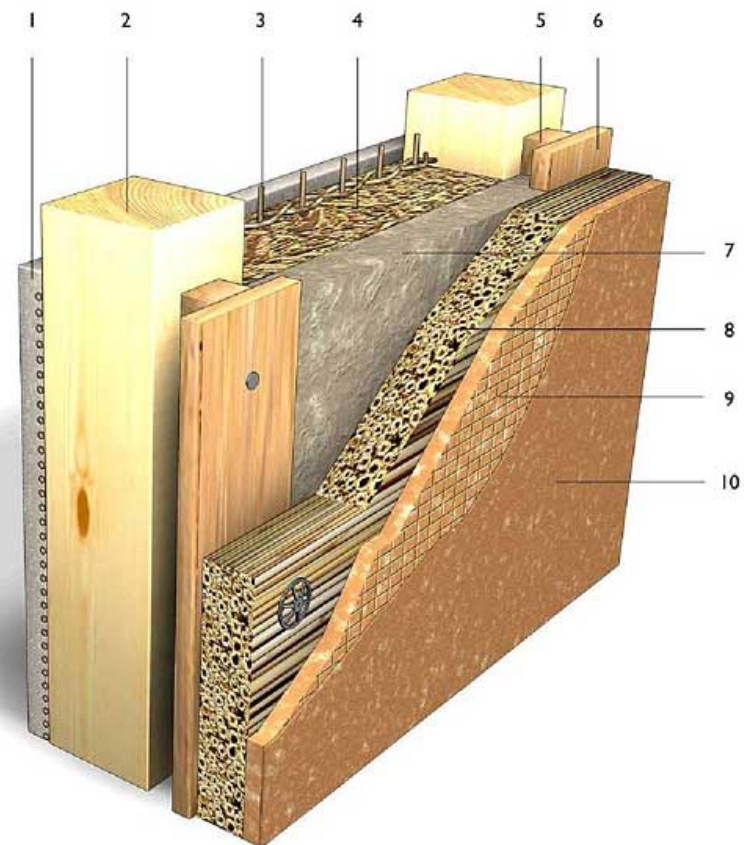


UNIVERSITÀ  
DEGLI STUDI  
FIRENZE  
Scuola di  
Architettura



INTERNATIONAL COURSE ON  
ARCHITECTURAL DESIGN

# INSULATION MATERIALS



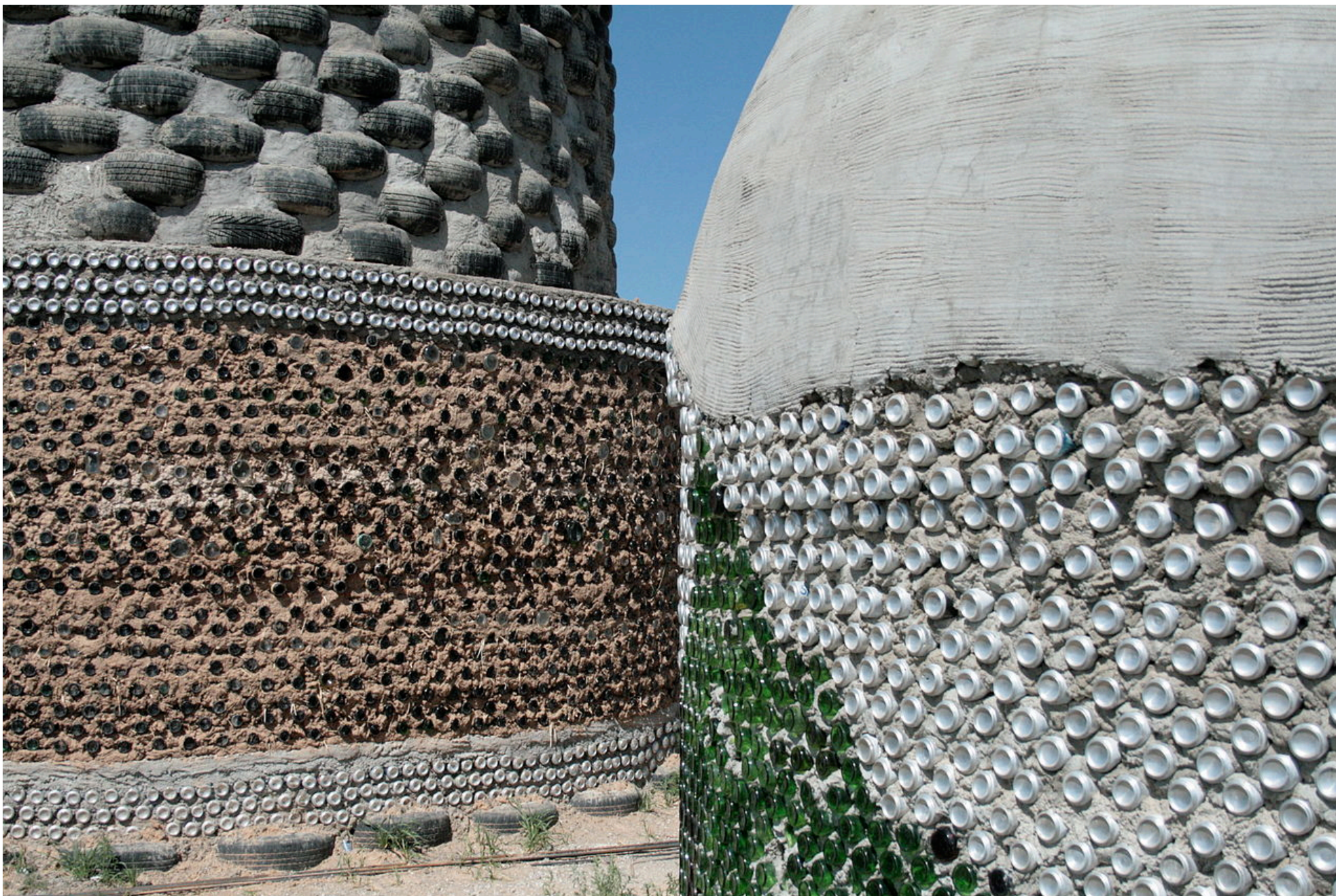


UNIVERSITÀ  
DEGLI STUDI  
FIRENZE  
Scuola di  
Architettura



INTERNATIONAL COURSE ON  
ARCHITECTURAL DESIGN

# INSULATION MATERIALS





UNIVERSITÀ  
DEGLI STUDI  
FIRENZE  
Scuola di  
Architettura

**iCAD**

INTERNATIONAL COURSE ON  
ARCHITECTURAL DESIGN

# INSULATION MATERIALS



## CONDUCTIVITY VALUES

### Sintesi conduttività – prodotti “normali”

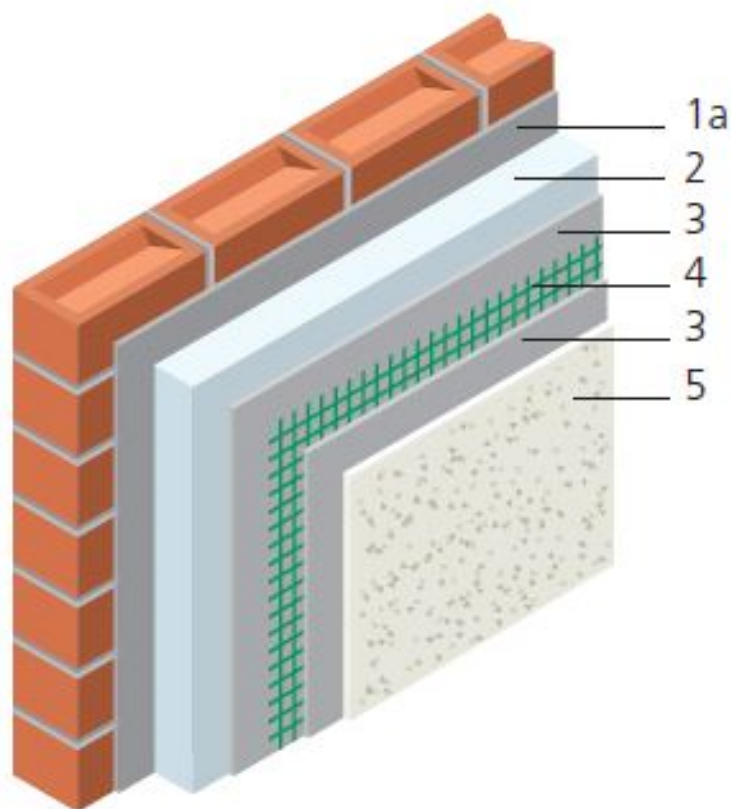
Materiale	Peso specifico nominale $\rho_a$ kg/m <sup>3</sup>	Conduttività termica Valore nominale $\lambda_D$ (vedi Capitolo 2)	
		verificato <sup>1</sup> W/(m · K)	non verificato W/(m · K)
<b>Lana di vetro</b>			
Pannelli, stuoie, rotoli	10–120	0.031–0.048	0.055
Sfusa	30–100	<sup>2</sup>	0.060
<b>Lana di roccia</b>			
Pannelli, stuoie, rotoli	15–200	0.034–0.048	0.055
Sfusa	30–100	<sup>2</sup>	0.060
<b>Schiuma di vetro</b>			
Pannelli	100–150	0.040–0.055	0.064
Sfusa	250–450	<sup>2</sup>	0.094
<b>Perlite, Vermiculite sfusa</b>	50–130	v0.084	
<b>Polistirolo, espanso (EPS)</b>	30–15	0.032–0.042	0.048
<b>Polistirolo, estruso (XPS)</b>			
Polistirolo, estruso (XPS)	25–65	0.028–0.036	0.043
Contenuto cellulare Aria	25–65	0.034–0.038	0.046
<b>Poliuretano (PUR) e poliisocianurato (PIR)</b>			
Contenuto cellulare Pentano			
impermeabile alla diffusione	28–55	0.022–0.027	0.032
permeabile alla diffusione	28–55	0.026–0.033	0.037
Contenuto cellulare CO <sub>2</sub>	35–60	0.032–0.038	0.045

### Sintesi conduttività – prodotti “bio”

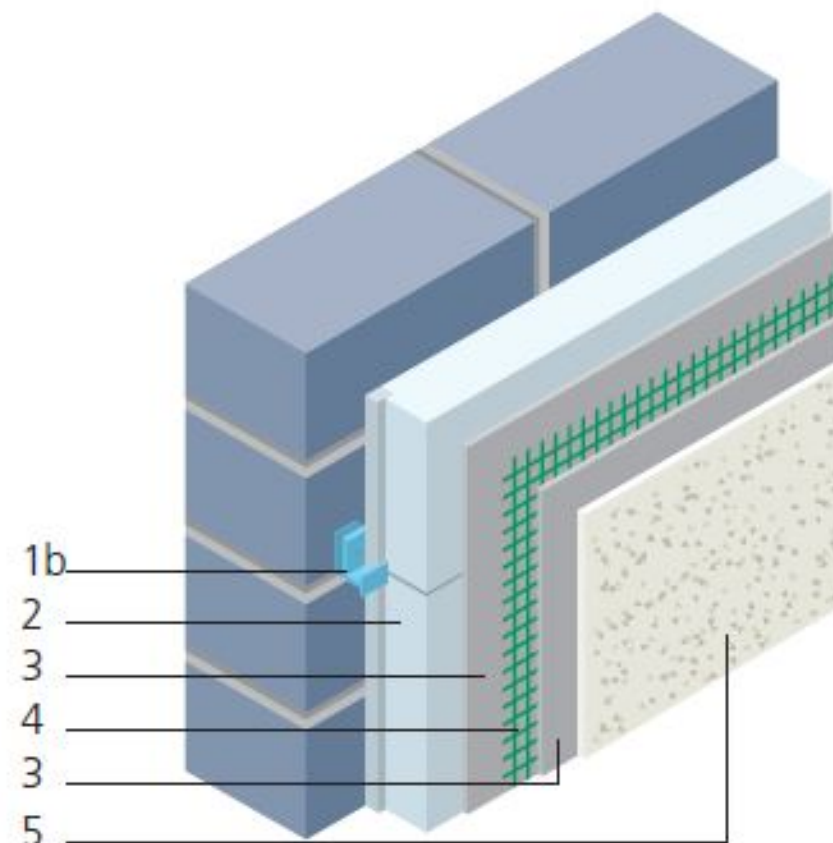
Materiale	Peso specifico nominale $\rho_a$ kg/m <sup>3</sup>	Conduttività termica Valore nominale $\lambda_D$ (vedi Capitolo 2)	
		verificato <sup>1</sup> W/(m · K)	non verificato W/(m · K)
<b>Sughero: pannelli, stuoie</b>	90–160	0.040–0.047	0.056
<b>Lana di legno</b>			
Pannelli	30–150	0.067–0.089	0.107
Pannelli strutturali leggeri	250–450	<sup>2</sup>	0.095
Rivestimenti di pannelli multistrato <sup>3</sup>			
5 mm	<sup>2</sup>	<sup>2</sup>	0.15
7,5 mm	<sup>2</sup>	<sup>2</sup>	0.125
10 mm	<sup>2</sup>	<sup>2</sup>	0.10
<b>Pannelli isolanti in fibra di legno</b>	120–300 300–600	0.044–0.065 <sup>2</sup>	0.080 0.110
<b>Cellulosa</b>			
Pannelli	<sup>2</sup>	<sup>2</sup>	0.065
Sfusa	30–80	<sup>2</sup>	0.060
<b>Materiale isol. di orig. vegetale</b>			
Pannelli in fibra di lino	25–35	<sup>2</sup>	0.055
Pannelli in cannette palustri	150–200	<sup>2</sup>	0.072
Stuoie in fibra di cocco	50–100	<sup>2</sup>	0.066
Cotone	> 25	<sup>2</sup>	0.055
<b>Materiale isol. di orig. animale</b>			
Lana di pecora	20–60	<sup>2</sup>	0.055



## Adhesively fixed System

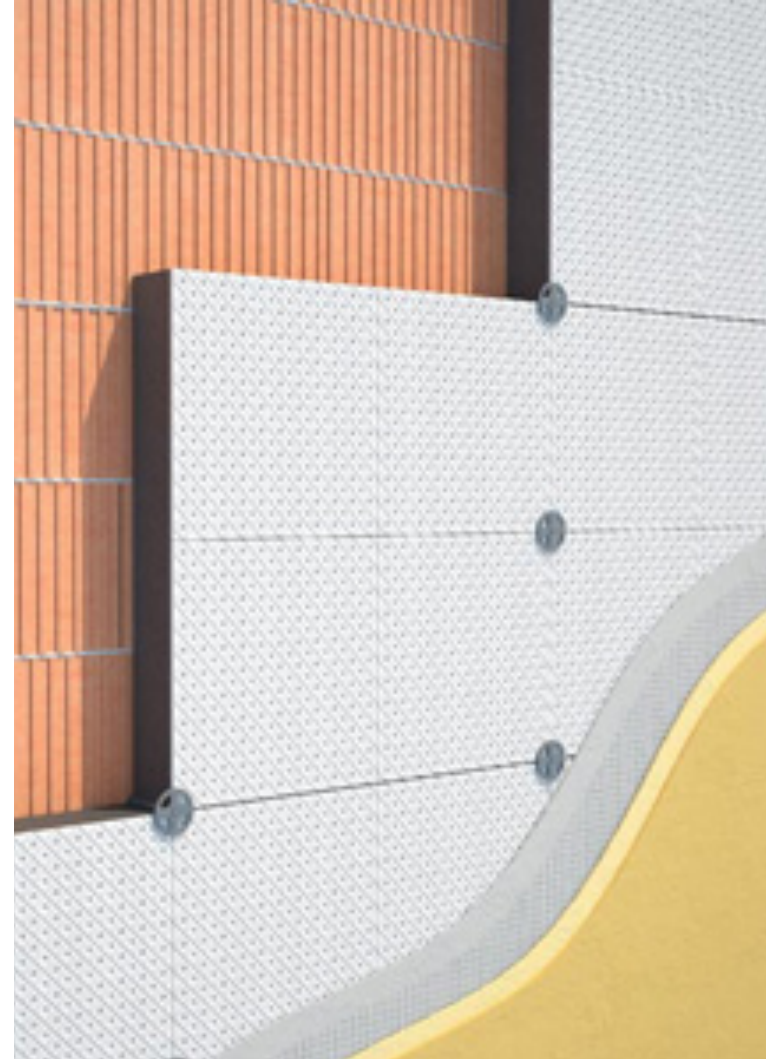
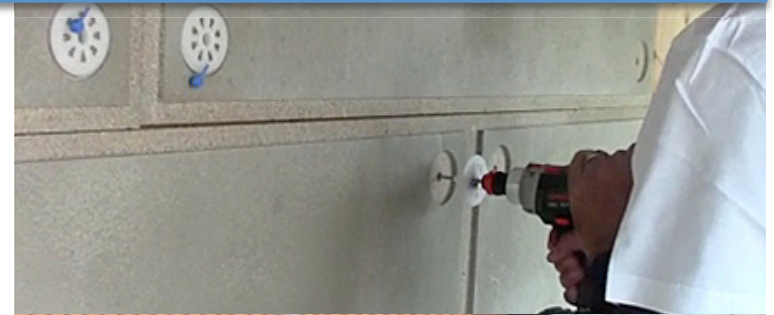


## Mechanically fixed System



- 1a: Adhesive fix    1b: Mechanically fixed track system  
2: Sto-EPS insulation board    3: StoArmat Classic reinforcing render  
4: Sto Glass Fibre Mesh    5: Sto decorative finish

# INSULATION APPLICATION AND FINISHING

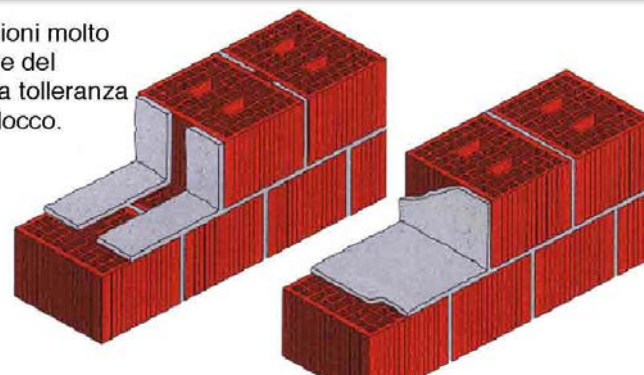


# INSULATION APPLICATION AND FINISHING

Il punto critico del sistema diventa il giunto di malta che, se realizzato con malta tradizionale ha un'elevata conduttanza. Allora si cerca di ridurre spessore, continuità e conduttività della malta utilizzata.

## With traditional mortar

il blocco ha dimensioni molto variabili, lo spessore del giunto dipende dalla tolleranza dimensionale del blocco.



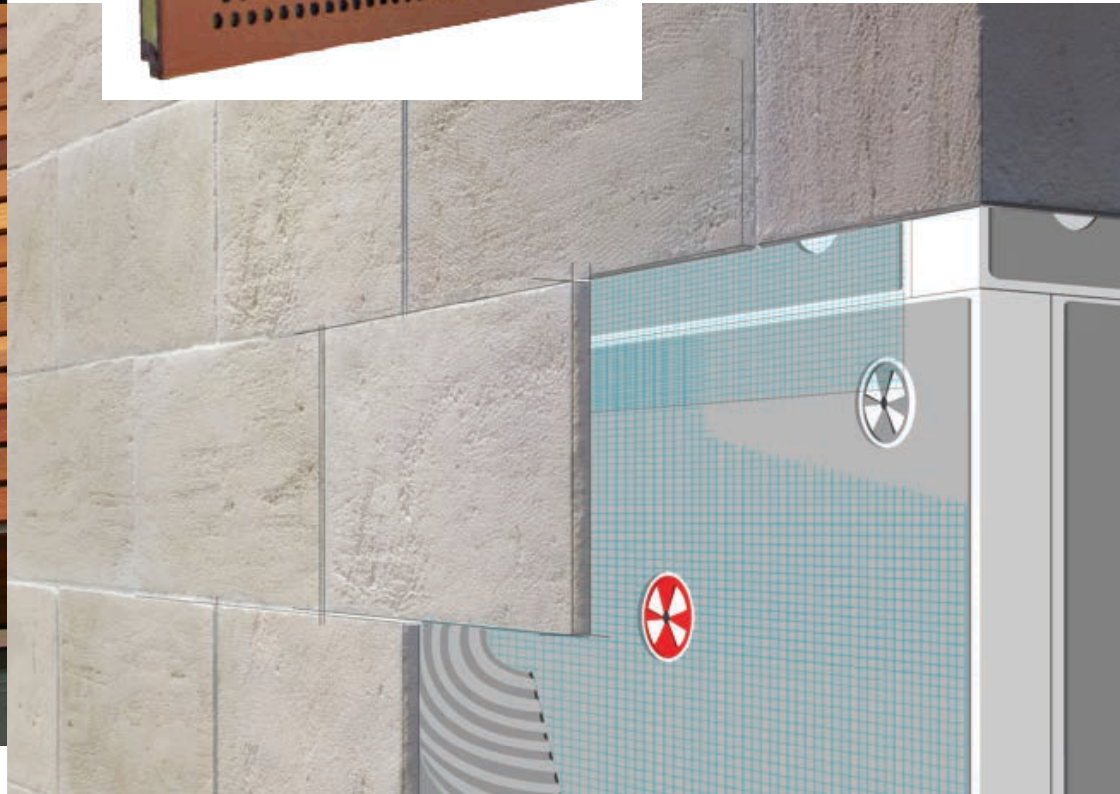
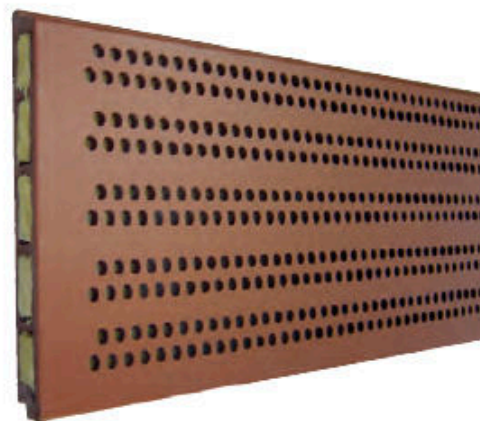
## With industrial mineral glue



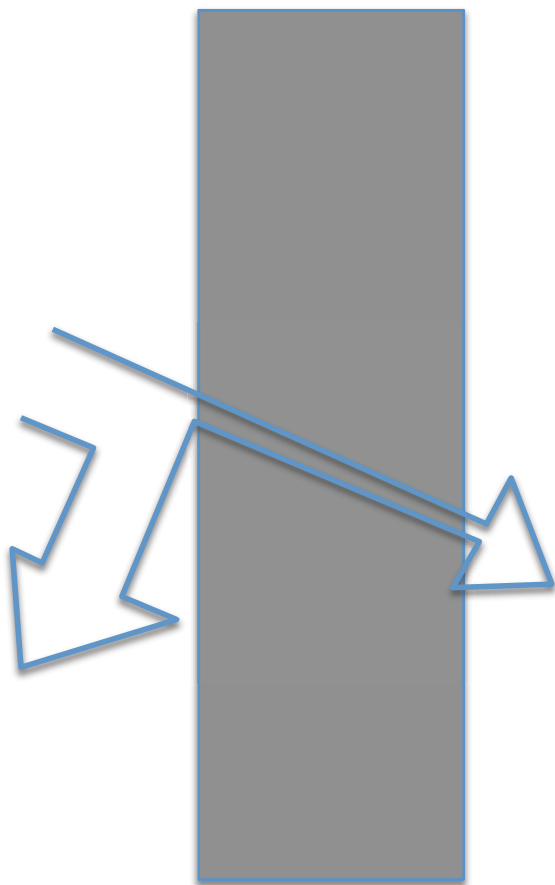
I sistemi “**moderni**” hanno bisogno di malte speciali per l'allettamento e per gli intonaci (basso mod. elastico, isolanti), di reti e pezzi speciali per mantenere stabili blocchi e rivestimenti.



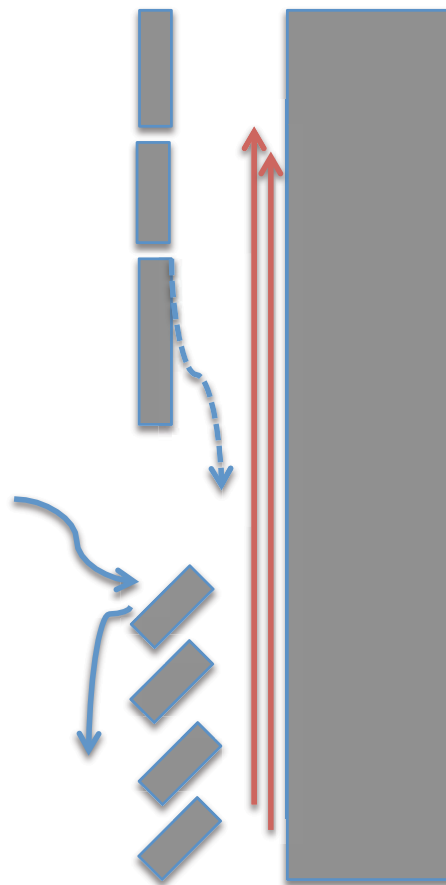
## PLASTER VS HARD FINISHING



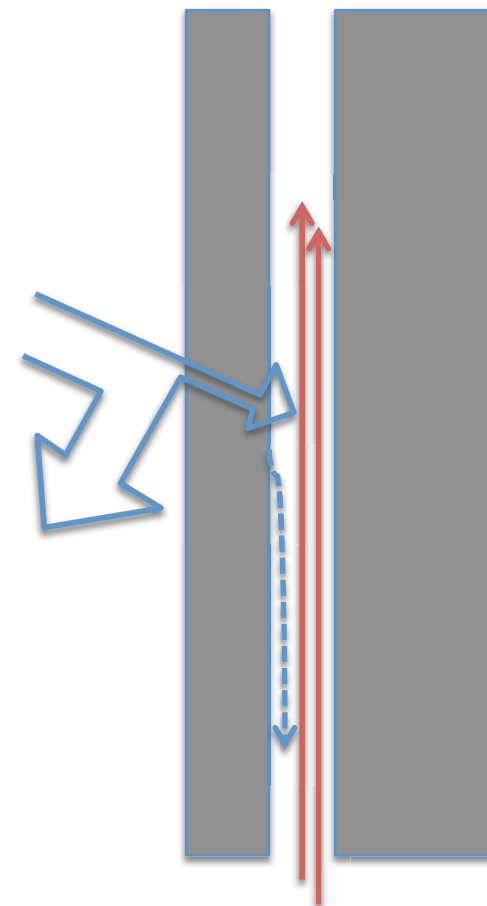
# VENTILATED WALL



TRADITIONAL WALL



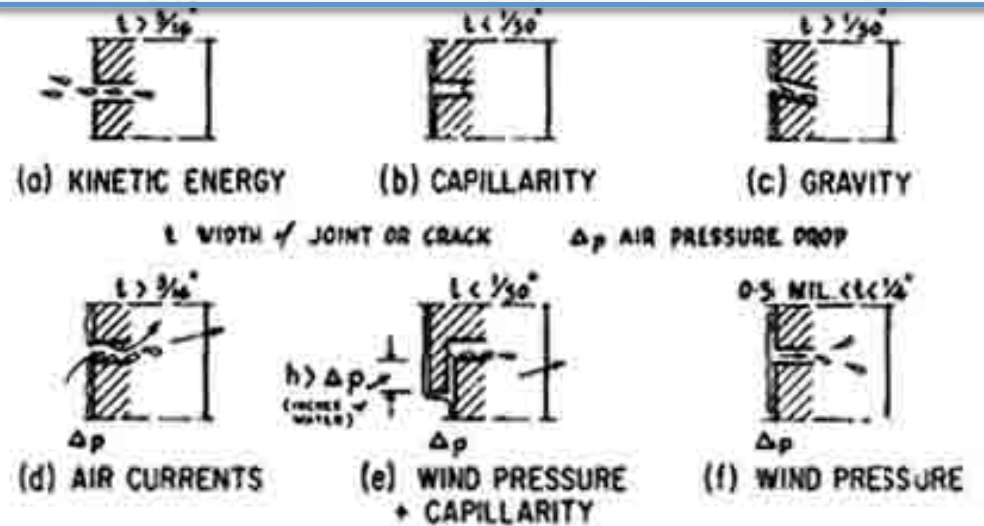
VENTILATED WALL



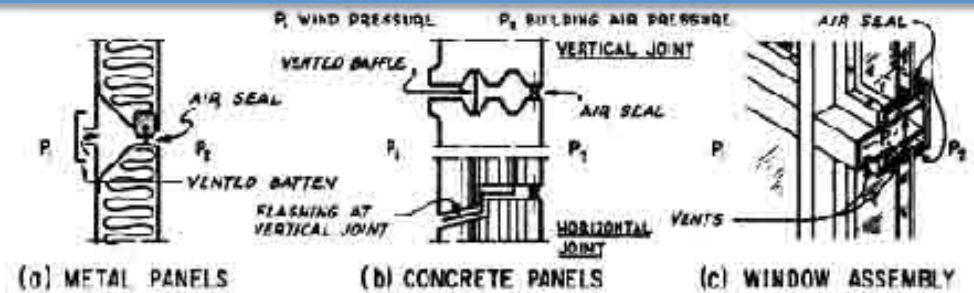
DOUBLE SKIN WALL

# VENTILATED WALL

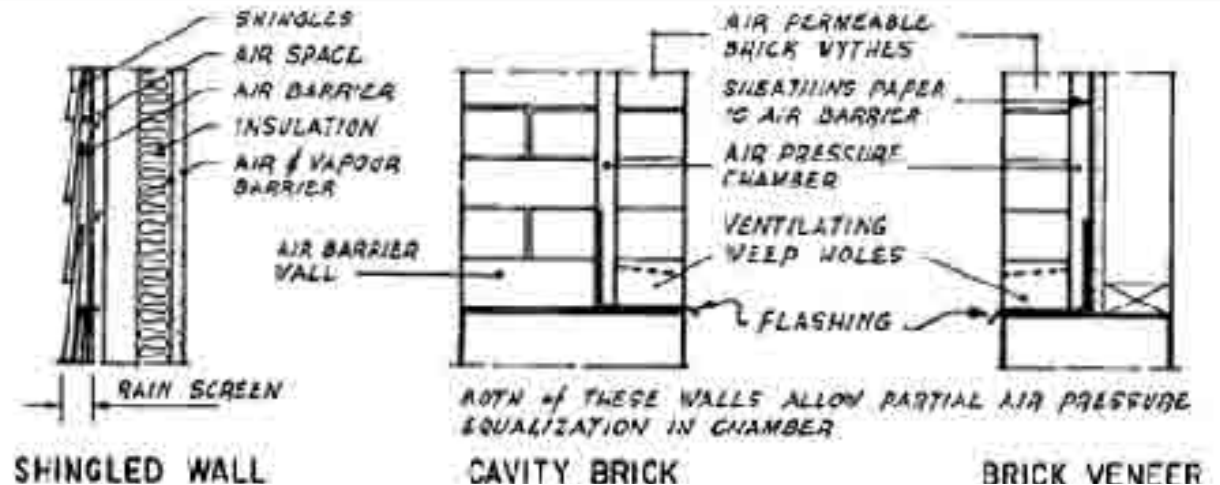
## FORCES PRODUCING RAIN PENETRATION

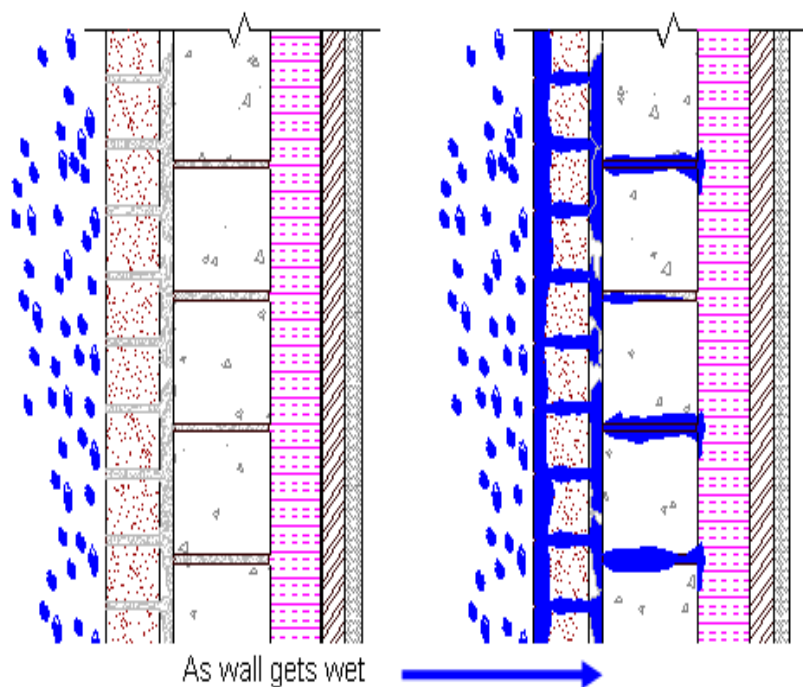
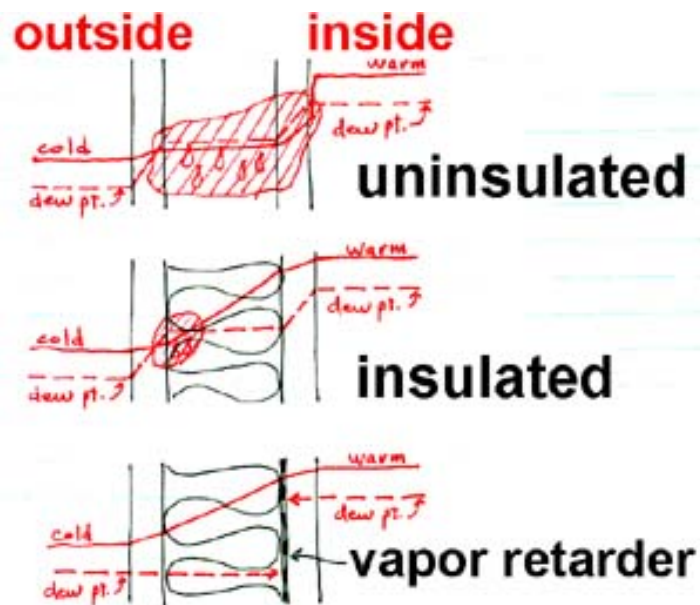


## JOINTS BETWEEN PREFABRICATED COMPONENTS



## TRADITIONAL WALLS THAT RESIST RAIN PENETRATION

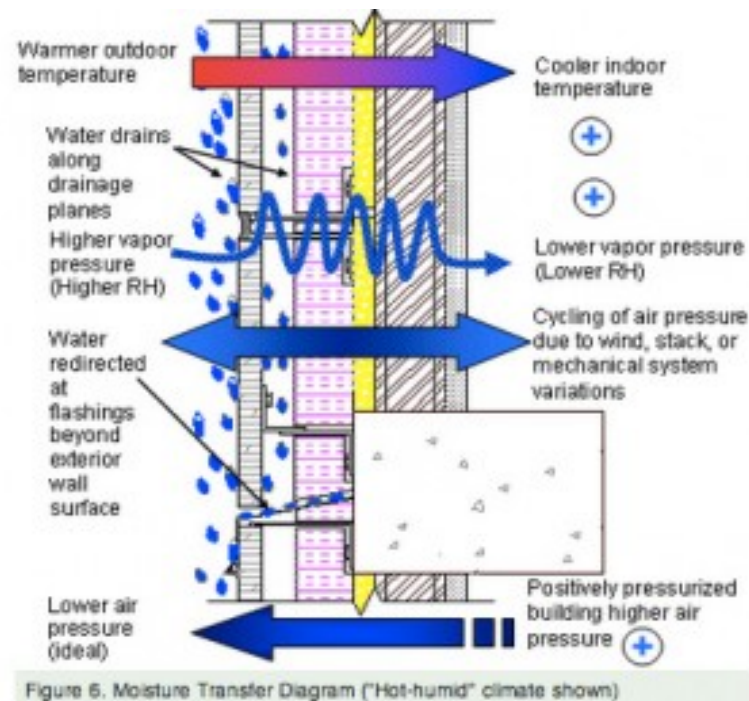




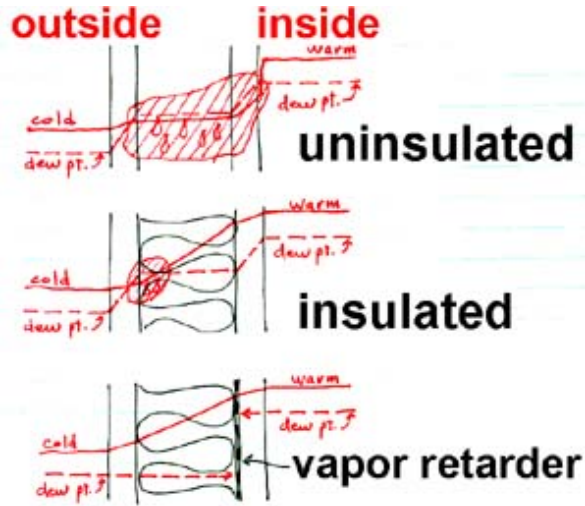
## VENTILATED WALL

From WIKIPEDIA:

The **dew point** is the [temperature](#) at which the [water vapor](#) in [air](#) at constant [barometric pressure](#) [condenses](#) into liquid water at the same rate at which it evaporates. At temperatures below the dew point, water will leave the air. The condensed water is called [dew](#) when it forms on a solid surface.



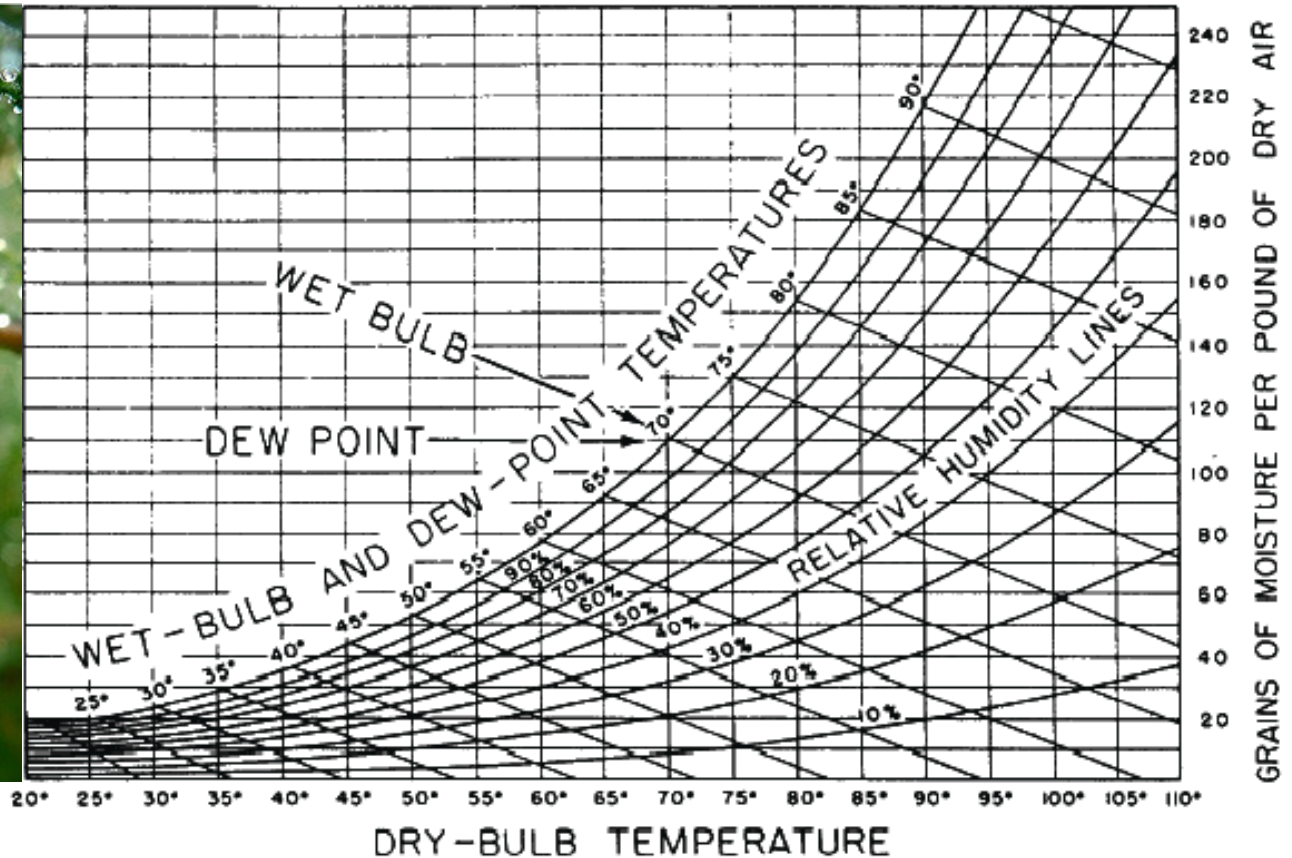
# VENTILATED WALL



From WIKIPEDIA:

The **dew point** is the [temperature](#) at which the [water vapor](#) in [air](#) at constant [barometric pressure condenses](#) into liquid water at the same rate at which it evaporates. At temperatures below the dew point, water will leave the air. The condensed water is called [dew](#) when it forms on a solid surface.

Simplified psychrometric chart.





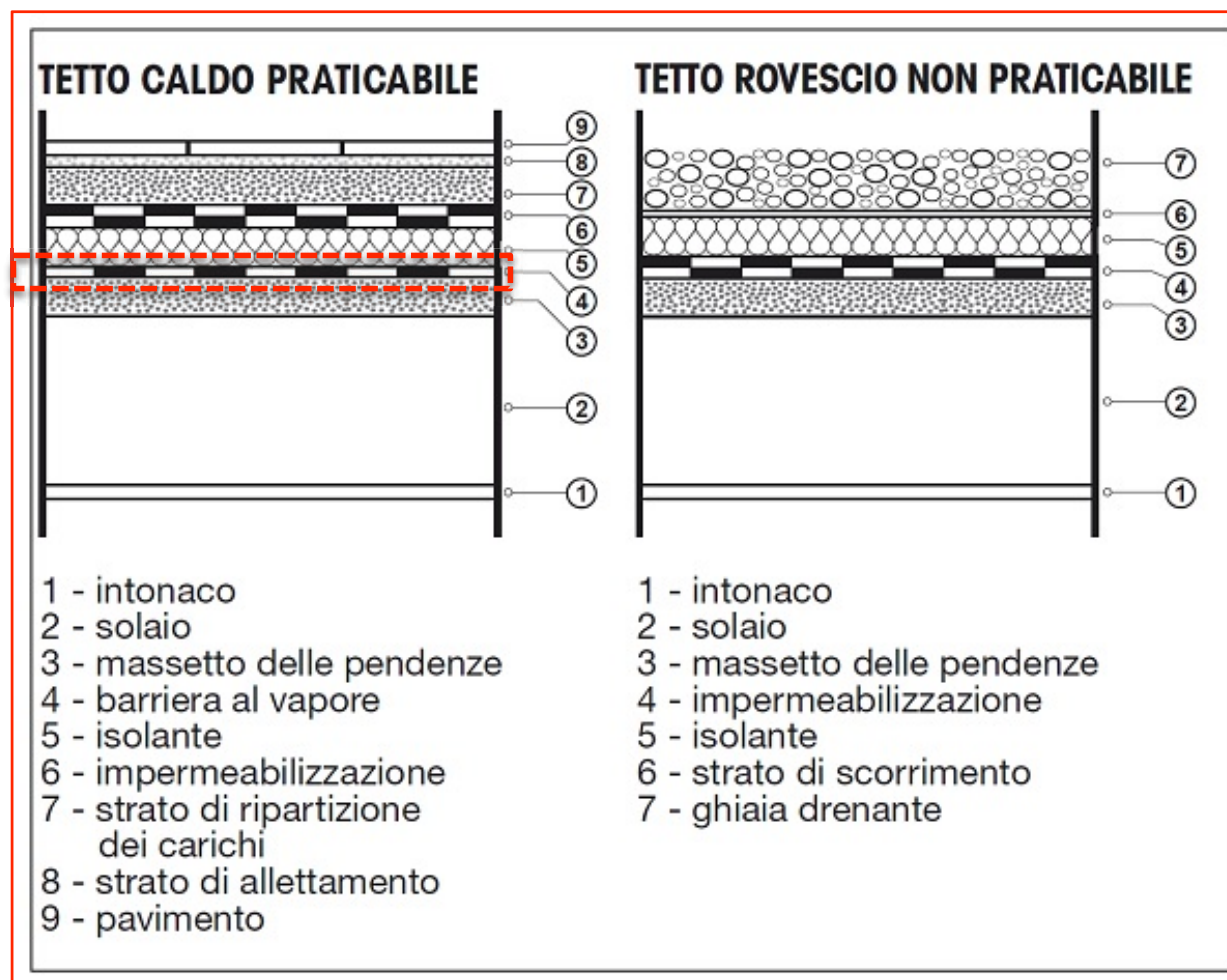
## WARM ROOF

## COLD ROOF

From WIKIPEDIA:

A **vapor barrier** (or **vapour barrier**) is any material used for [damp proofing](#), typically a plastic or foil sheet, that resists diffusion of moisture through wall, ceiling and floor assemblies of buildings and of [packaging](#).

Technically, many of these materials are only **vapor retarders** as they have varying degrees of [permeability](#).



## AGAINST A PERFECT SEALING CLADDING

«*The water will inevitably find a way into a wall*»

### Lessons from THE PACIFIC NORTHWEST

The toll of destruction over the past couple of decades waged by the damp climate of the Pacific Northwest is still being tallied. Buildings constructed during the 1980s and '90s in this region, which includes Seattle, Portland, and Vancouver, have experienced widespread damage due to early failure of their building façades.

For example, it is estimated that 45-55% of condominiums constructed in coastal British Columbia between 1982 and 1999, including almost 6,000 condo buildings in the Vancouver area alone, have already suffered from premature building enclosure failure. This has resulted in multiple billions of dollars in repair costs to British Columbia building owners, with similar failures occurring throughout coastal Washington and Oregon.

A conflux of conditions has led to the failures of these building enclosures. The climate has extended periods of wetting, with little drying during those periods, allowing wet walls to remain wet for a long time. The widespread use of perfect barrier cladding assemblies in wall construction, particularly in wood-framed condos but also in concrete and steel-framed buildings, provided a massive inventory of walls that have no redundancy for managing incidental moisture ingress. In particular, the use of stucco cladding applied directly over felt building paper and wood sheathing, all permeable materials, easily allowed walls to slowly absorb moisture and fail systemically due to rot, mold, and leaks.

The region has been repairing these façades since the mid-1990s, in many instances removing the cladding and sheathing assembly from an entire building down to the studs, and installing new sheathing and rainscreen wall assemblies from the existing studs outward. Recladding the failed buildings with rainscreen wall assemblies appears, thus far, to have been successful in managing the moisture in walls. Rainscreen wall assemblies are so predominant a rehabilitation solution in the region that they are now mandated in the building codes of British Columbia.

'Perhaps the rainscreen approach will be the tool that allows our design aspirations to take a humble, imperfect step further in our perpetual quest for perfection.'



A terra cotta façade system incorporating multilayer water penetration protection.



Installation of a rainscreen system. "The rainscreen approach operates on the assumption that water will inevitably find a way into a wall," says building envelope expert Bradley Carmichael.

## MOISTURE INGRESS AND HYDRODYNAMICS

Our relationship with water has always been enigmatic. It creates us, nurtures us, cleans us, comforts us, and destroys us. We walk through the rain with little question of harm, yet a constant drip can bore holes through stone and steel. Since water has been responsible for untold levels of damage and destruction to buildings, it is in furthering our understanding of it that we hope to better protect our buildings.

The climate in which a building is constructed will often dictate the extent of moisture protection necessary to the design. Humidity and precipitation data provide key indicators of the cumulative moisture to which a building will be exposed during storm events and over time, but beyond this, climatic factors such as prevailing wind directions, airborne salinity in coastal regions, the balance of wetting periods to drying periods, and the balance of freezing periods to

thawing periods are important additional considerations when establishing the required level of moisture protection.

There are many ways for water to break beyond the outer building skin. Leaks through building façades via cracks, gaps, and holes generally offer the first easy avenue for water infiltration. These entry points are more apparent and easier to control than some of the more subtle, yet still damaging, pathways.

Much smaller cracks, holes, and pores in building materials can also effectively move water into the building through a phenomenon called *capillary action*. This occurs when the surface tension of the water reacts with the surface of the surrounding walls of a material opening, in small diameters, to draw itself up against the forces of gravity. This happens naturally in porous construction materials, such as wood, brick, and concrete, but it can occur through minute openings in nonporous construction materials as well.

Water will also find its way into wall assemblies in vapor form. This happens when moisture-laden air passes through an air-permeable wall assembly, and vapor condenses on surfaces within the wall. Water vapor infiltration commonly occurs when moist air is driven into the wall from the outside, or when air from humid building interiors migrates into the wall assembly.

The forces that drive moisture into a wall are varied and may include any combination of gravity, kinetic energy from wind, pressure differentials across the wall assembly, and even temperature differentials causing inward solar vapor drive. Because these forces interact in complex ways, moisture control demands more than simply plugging all of the visible gaps and cracks in the wall. It was not until the building industry understood and accepted this principle that the notion of abandoning the perfect barrier in favor of a multi-layered approach first began to take hold.

## MOISTURE CONTROL STRATEGIES

For all their variation in color, texture, and style, most buildings rely on a surprisingly limited set of strategies for keeping water out. Let's look at several of the primary strategies that have been widely implemented for controlling moisture and preventing leaks.

Our earliest buildings were constructed long before the advent of waterproofing membranes, and yet many of the water-protection methods used then are still used today. The predominant strategy used in historic construction, and still in use today, relies on the mass of the wall material itself for moisture management. This strategy is commonly employed with solid concrete, stone, brick, and other types of masonry. Provided the wall has sufficient mass to absorb and store moisture during periods of wetting until it can eventually evaporate during periods of drying, the risk of leaks can be greatly mitigated. One reason this method has been so common throughout history is that the mass of the wall was also required for the structural support of the building, something that is less of a consideration today.

As construction technologies progressed through modern times, the need for massive walls declined, and slimmer and more easily

constructed wall types became more prevalent.

Many of these newer wall systems rely on a waterproof cladding surface and impervious sealed joints to eliminate water entry points. In practice, such assemblies rarely achieve a perfect barrier, not only because complexities of the systems make absolute water tightness difficult, but also because the forces of nature and aging lead to eventual degradation and failure of components. This approach to controlling moisture in walls tends to be cheaper to install than other system types, but the cost of ongoing maintenance, damage repair, and eventual replacement can be considerable.

Another approach that has been widely used in lighter wall construction involves a masonry veneer with a cavity between the exterior and interior surfaces, for the purpose of drainage and ventilation. Lacking the storage capacity of their solid-mass counterparts, masonry veneers are designed on the principle that moisture penetrating the outer layer will dry or drain, via gravity, back to the exterior through weep holes at the bottom of the cavity. However, the space between the inner and outer layers must be large enough to avoid capillary action.

Building upon the cavity wall concept of earlier masonry veneers, the rainscreen approach operates on the assumption that water will inevitably find a way into the wall, and so provides multiple, redundant provisions for controlling water infiltration into the building. Like masonry veneers, rainscreens incorporate a secondary drainage plane behind the cladding to dissipate moisture through the combined action of gravity and evaporation. What distinguishes rainscreen wall systems is the addition of elements that further mitigate moisture ingress by restricting air movement and balancing pressures across the wall assembly.

When properly designed and detailed, exterior walls incorporating rainscreen principles can effectively protect the wall from moisture damage, even in climates prone to significant rainfall. This is because the rainscreen approach doesn't depend on any one element

to provide perfect waterproofing protection, but instead relies on the combined effect of a multi-component strategy.

## ANATOMY OF A RAINSCREEN

In its most elemental form, the rainscreen approach incorporates six basic functions into the design: the *cladding*, a *cavity*, one or more *thermal layers*, an *air barrier*, a *moisture barrier*, and the *supporting wall*. In some instances a vapor barrier is also included, but that is largely dependent on the particular façade design and conditions. The applications of this approach are diverse, from walls constructed of individual elements each serving a different function, to prefabricated wall cladding systems with components that serve multiple functions, to windows and curtain wall units that perform most or all functions.

**Cladding.** The exterior cladding is the visible surface of the wall assembly and the basic water-shedding layer. As the outermost portion of the façade, the cladding is exposed directly to the elements, and so must be designed to withstand long-term weathering. To minimize the amount of moisture that passes into the wall system, the cladding must also shed the majority of water it encounters. The rainscreen approach to cladding is unique in that this initial barrier does not necessarily need to be perfectly watertight. In fact, incorporating open joints and vents into the outer layer is often necessary for ventilation and drying of the cavity behind the cladding, as well as for balancing the pressure across the cladding surface.

**Cavity.** The cavity behind the cladding serves as a means to reduce the impact of moisture that passes beyond the outer layer of the wall assembly. The cavity drains incidental moisture via gravity to through-wall flashings, dries the wall assembly through ventilation, and breaks the surface tension of water to stop capillary action. The cavity does take up valuable real estate within the space of the wall, but in return it adds considerably to the longevity of the wall assembly.

FIGURE 1. TYPICAL RAINSCREEN CONFIGURATION

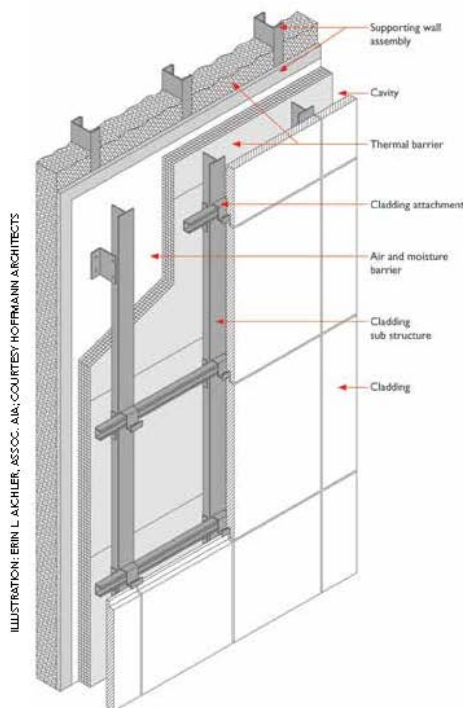


ILLUSTRATION: ERIN L. ACHER, ASSOC. AIA; COURTESY: HOFFMANN ARCHITECTS



Water washing down the face of this sandstone veneer façade has led to staining and algae growth, the latter of which can deplete indoor environmental quality, with potential negative consequences for occupant health.



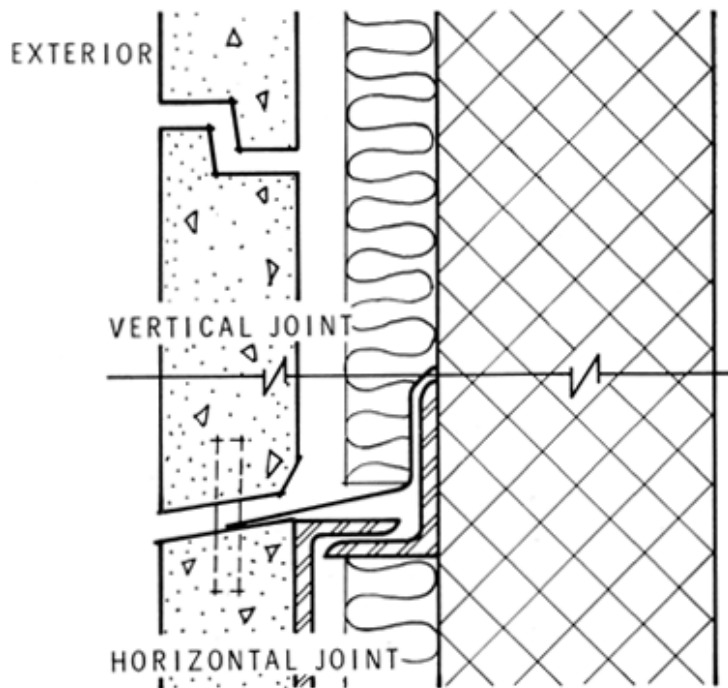
Evidence of moisture damage at this face-sealed EIFS assembly includes corrosion, delamination, and mold. EIFS manufacturers have improved these systems to prevent such failures in properly installed assemblies.

Sistemi di facciate ventilate

La facciata ventilata consente:

- la realizzazione di un isolamento termico potenzialmente continuo (att. balconi e gronde);
- la protezione dall'acqua meteorica;
- la traspirabilità della parete;
- la protezione dall'irraggiamento solare, sfruttando l'effetto camino.

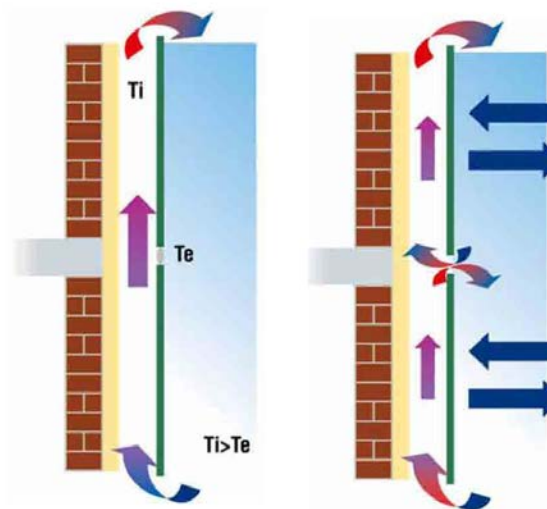
Sono costituite da una struttura metallica, ancorata alla struttura principale dell'edificio e da un rivestimento che può essere fatto con moltissimi materiali.



# VENTILATED WALL

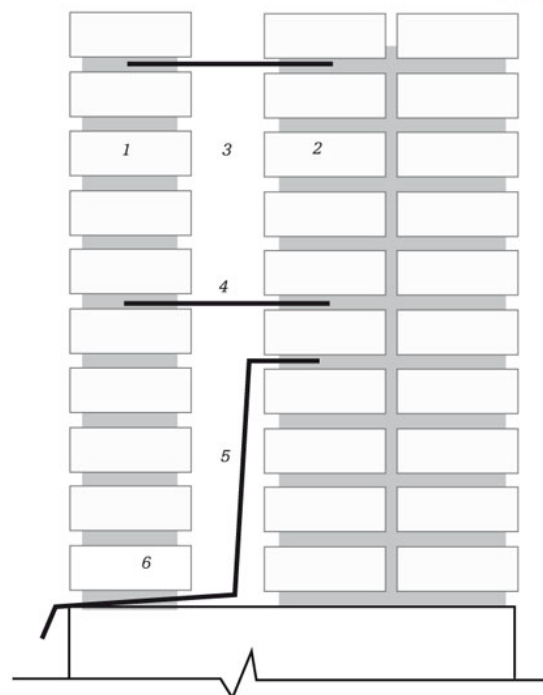
Sistemi di facciate ventilate

78



Attenzione:

- ai corti circuiti
- in condizioni estive l'aspirazione non è efficace oltre i due piani (6 metri)

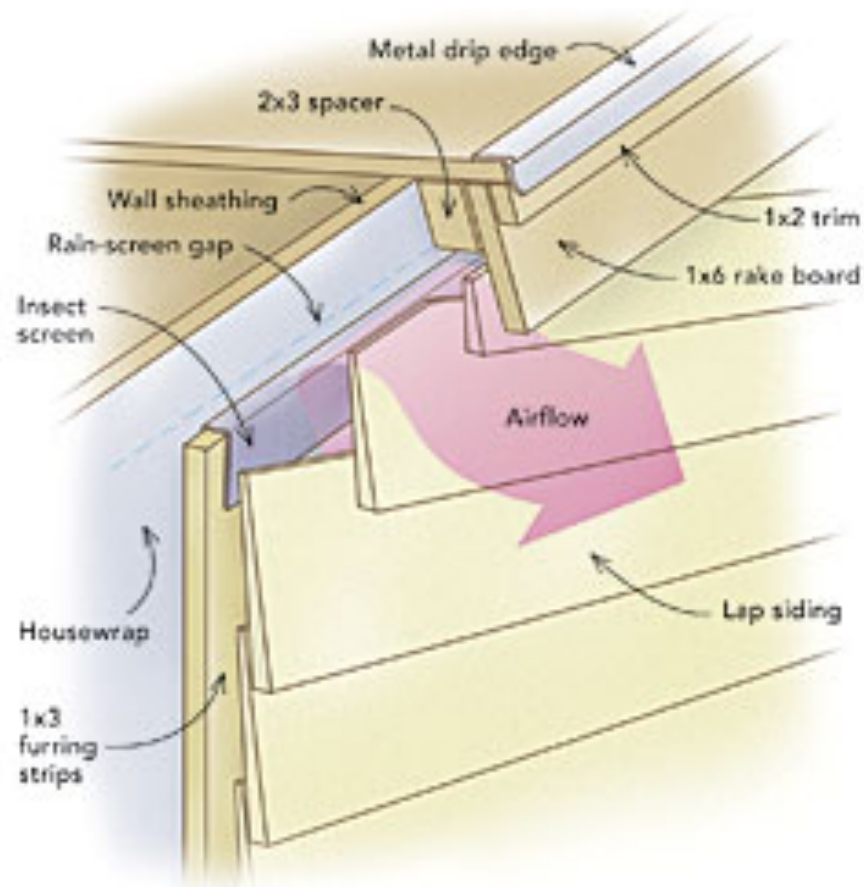


**How moisture penetrates**

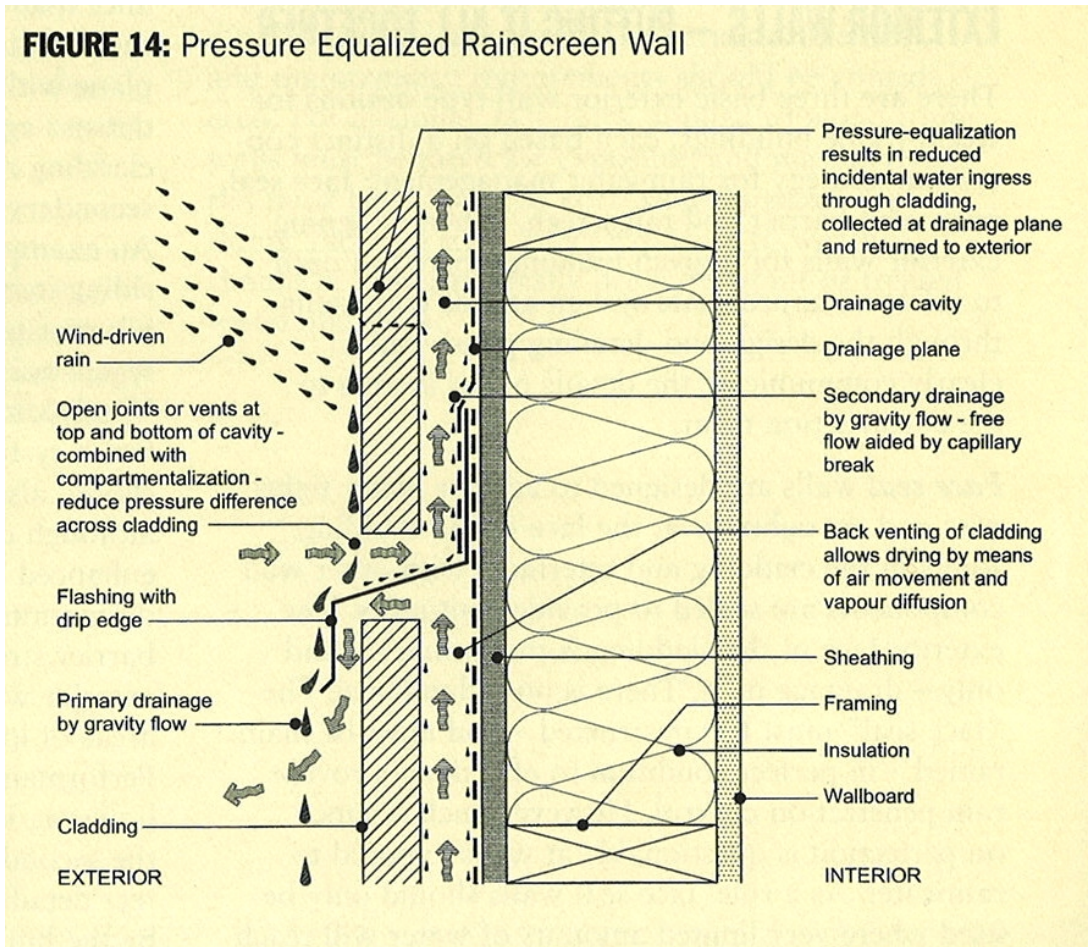
- Brickwork is not water resistant and water travels between the bricks and mortar by capillary action or wind pressure, depending on the size of the joint. This is exacerbated by poor workmanship. High risk zones are exposed edges and corners
- This water should drain down the inner face of the outer skin and through weepholes lower in the wall
- However, wall ties and cavity closers can, if not installed properly, provide a path for moisture to reach the inner wall. Water can also find its way through joints in insulation batts and through injected insulation

- 1 Outer brick skin
- 2 Inner wall
- 3 Cavity
- 4 Wall tie
- 5 Flashing
- 6 Weep hole

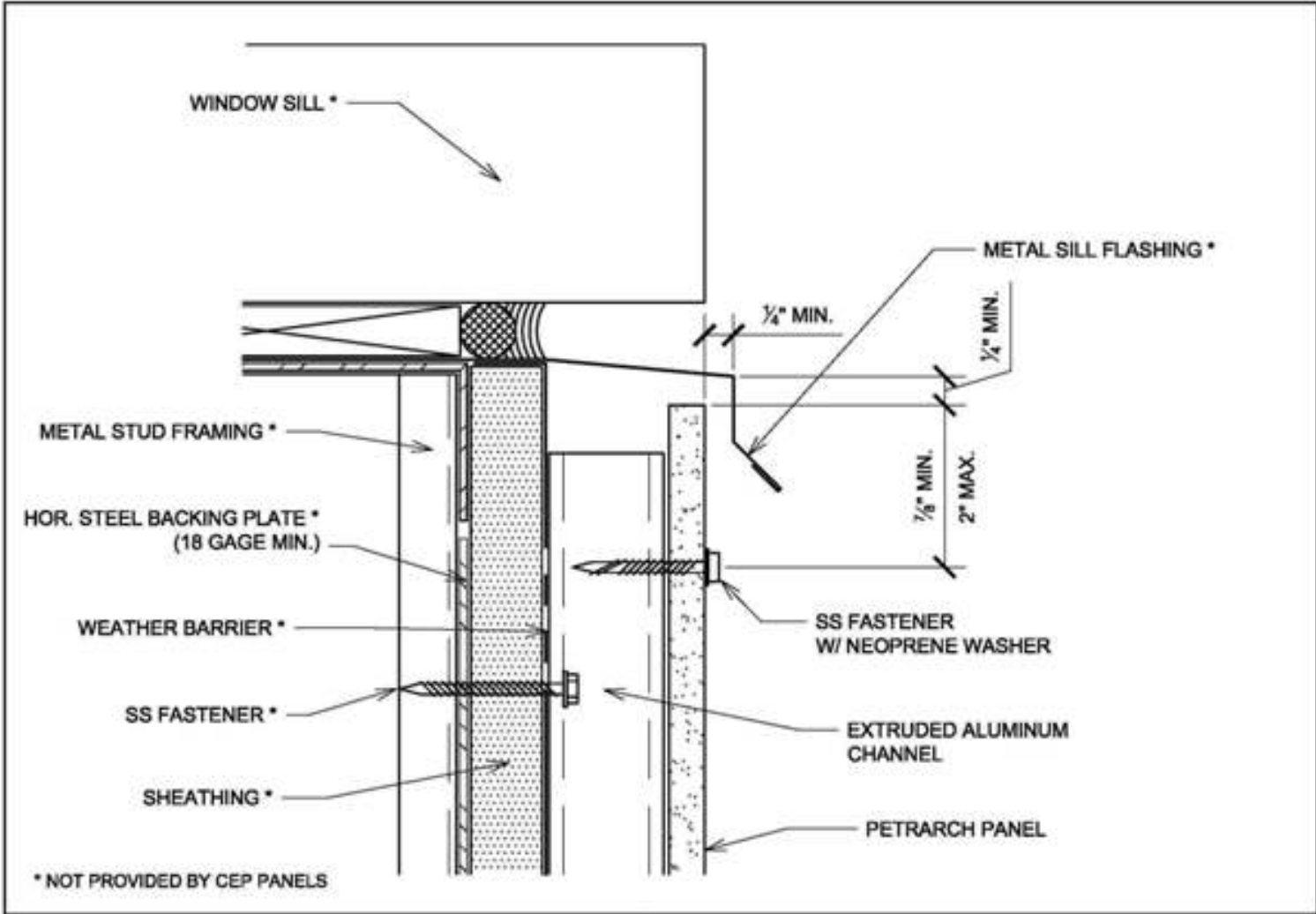
# VENTILATED WALL



**FIGURE 14:** Pressure Equalized Rainscreen Wall



# VENTILATED WALL



**CEP PANELS, INC.**  
RAIN SCREEN SYSTEM

15

WINDOW SILL

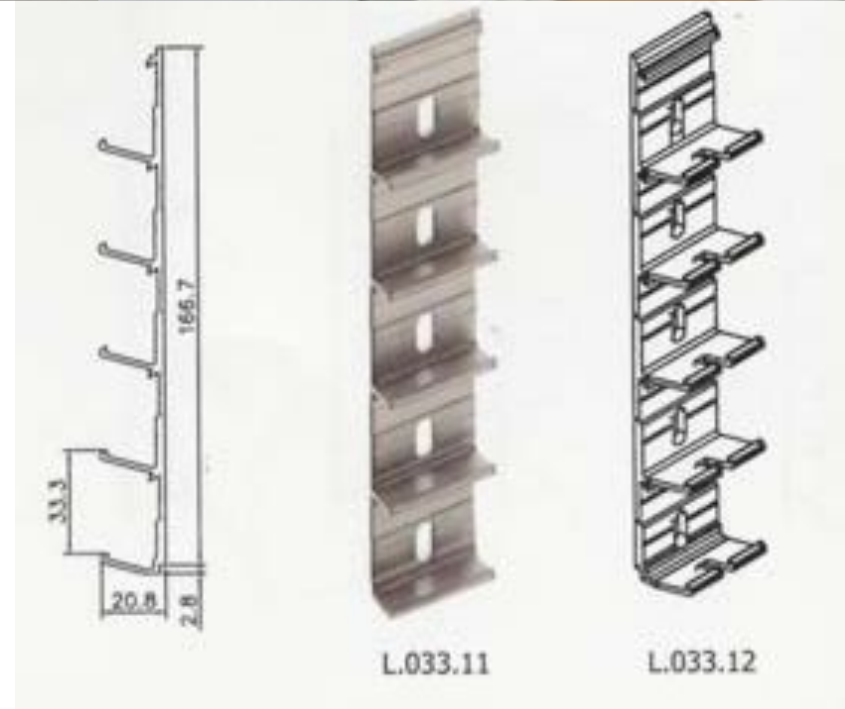
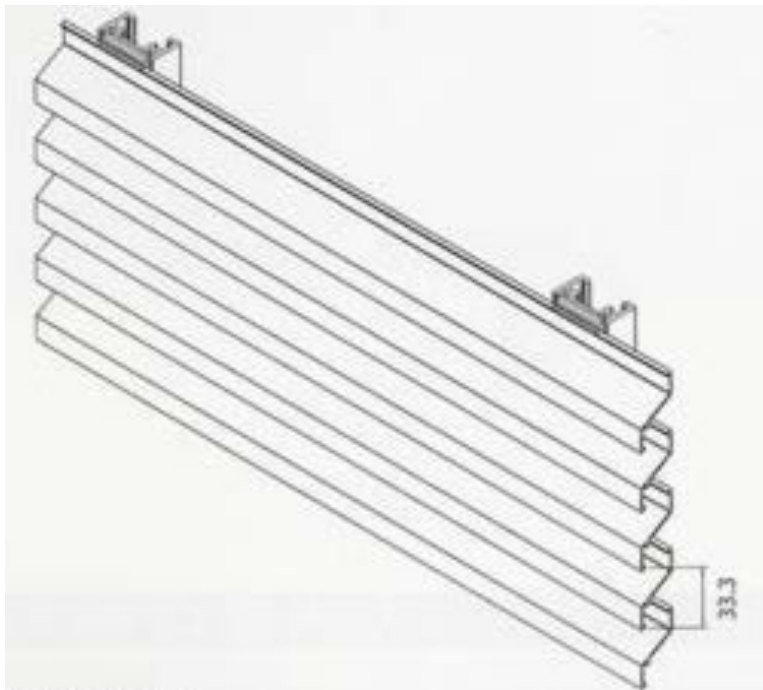


UNIVERSITÀ  
DEGLI STUDI  
FIRENZE  
Scuola di  
Architettura



INTERNATIONAL COURSE ON  
ARCHITECTURAL DESIGN

# VENTILATED WALL





UNIVERSITÀ  
DEGLI STUDI  
FIRENZE  
Scuola di  
Architettura

**iCAD**

INTERNATIONAL COURSE ON  
ARCHITECTURAL DESIGN

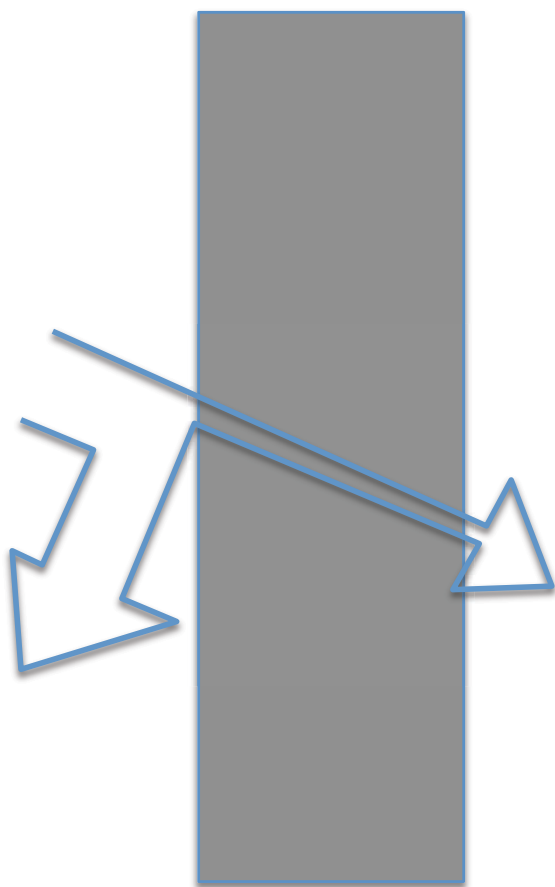
## VENTILATED WALL



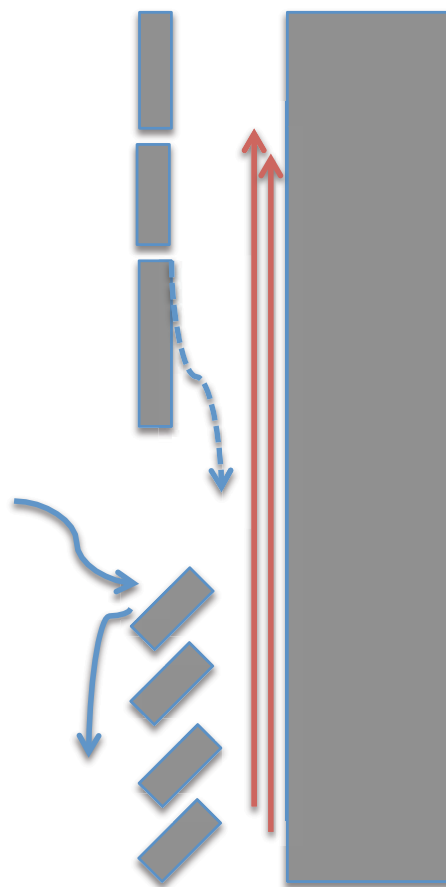


# DOUBLE SKIN WALL

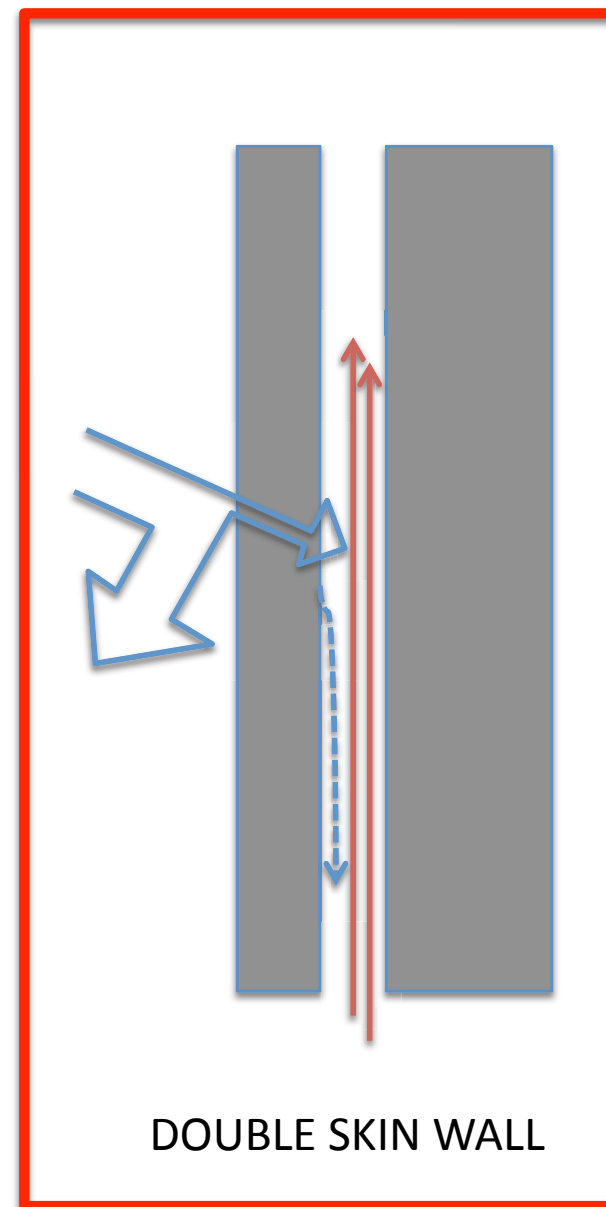
OR DOUBLE SKIN FAÇADE



TRADITIONAL WALL

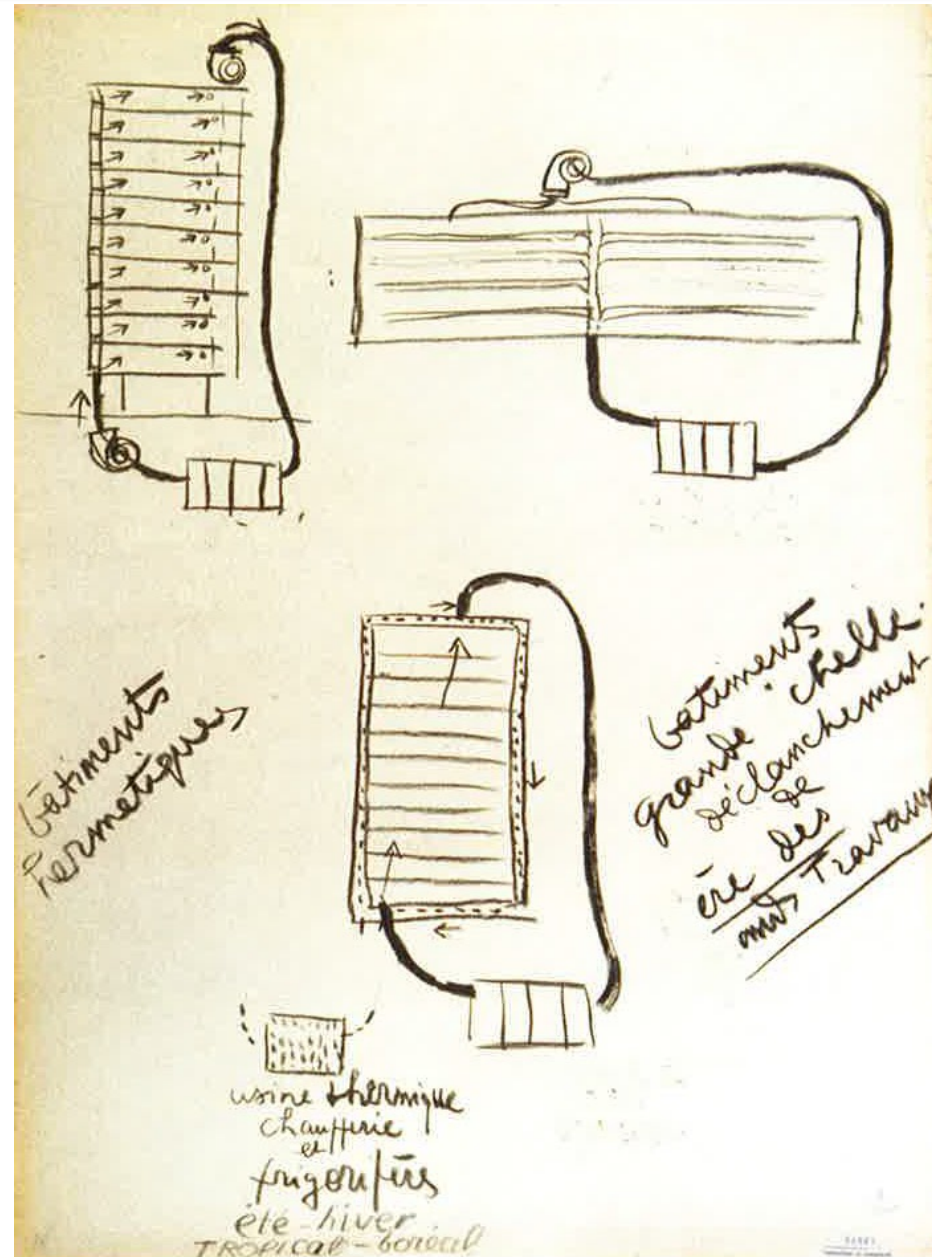
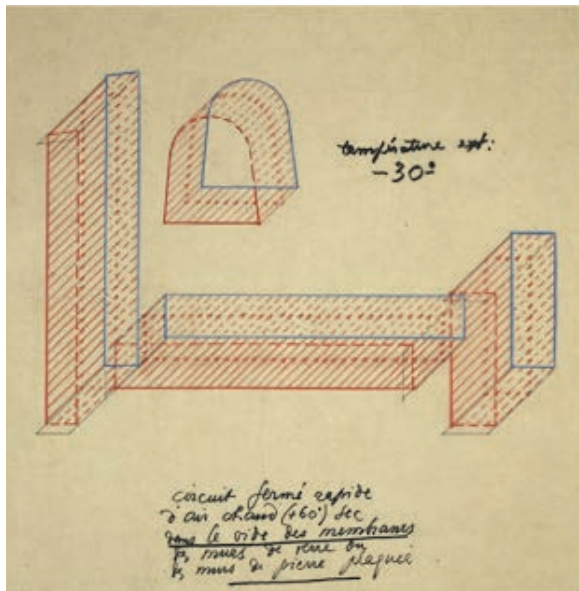
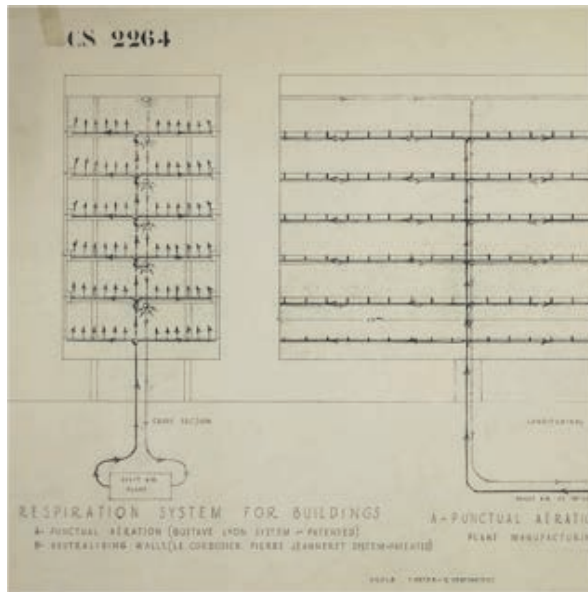


VENTILATED WALL



DOUBLE SKIN WALL

# DOUBLE SKIN FAÇADE

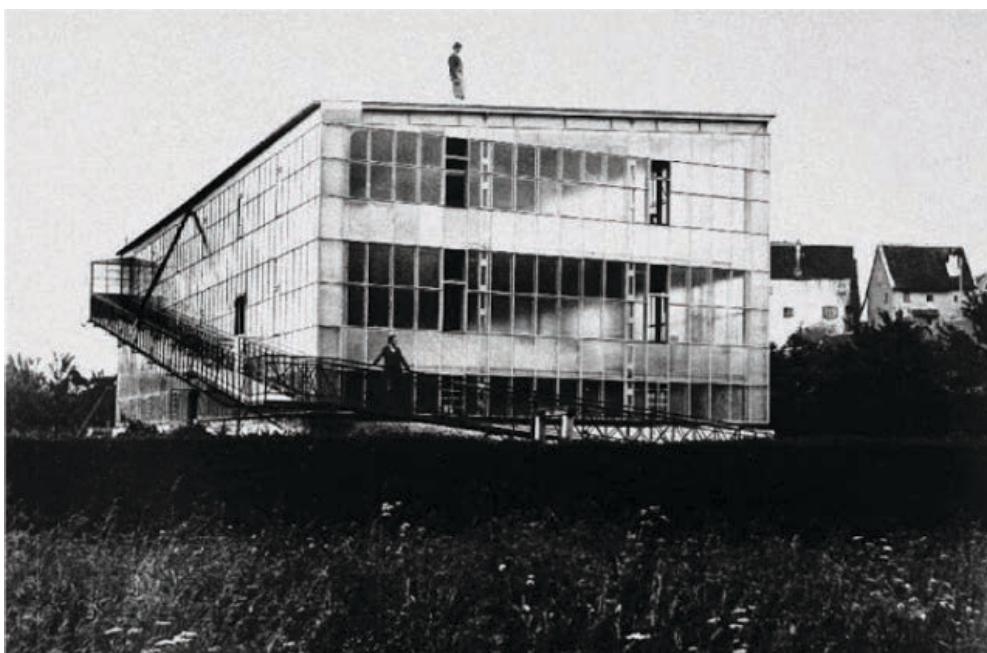
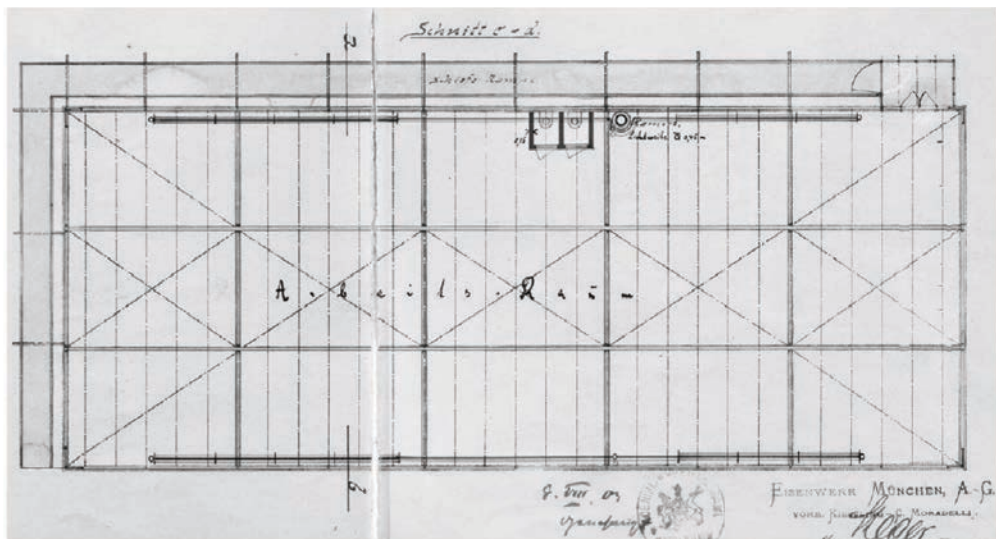


Mur neutralisant' and 'Respiration exacte'

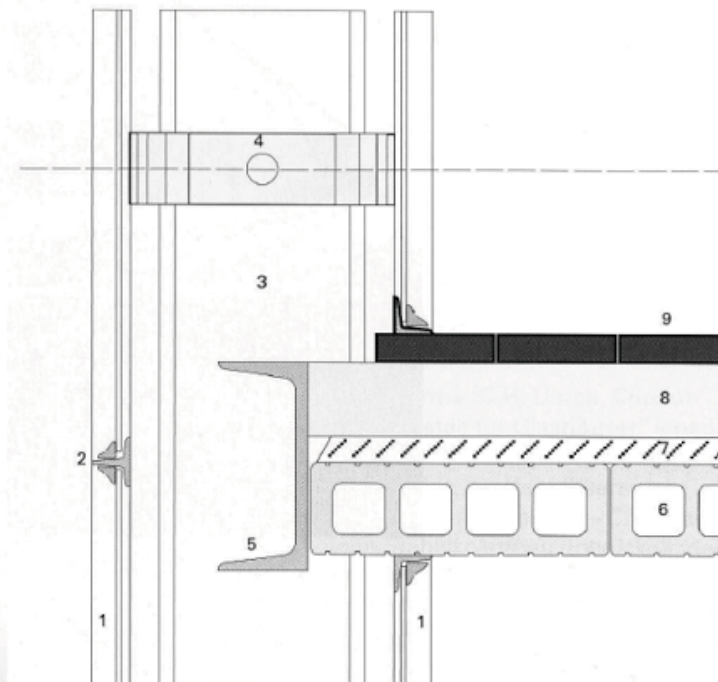
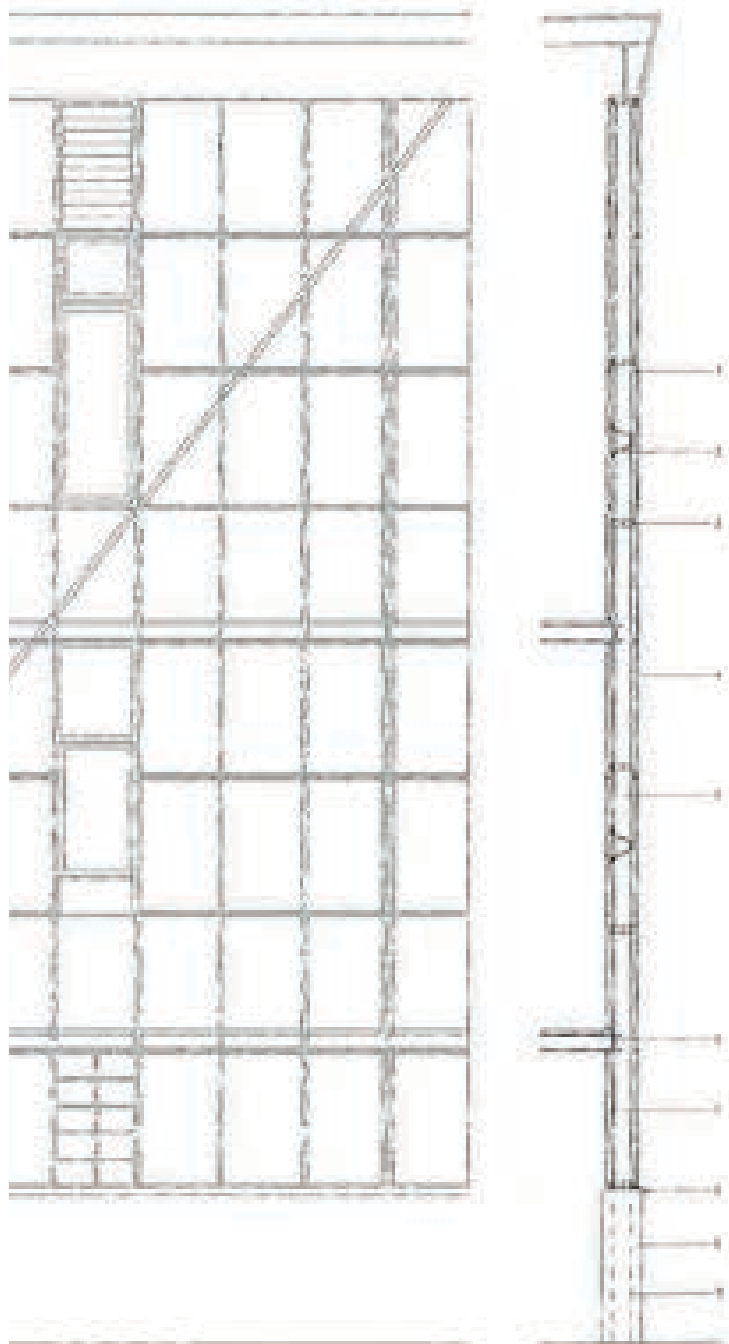
A poetic version of the mechanical ventilation system (Aération ponctuelle) used by Gustave Lyon at the Pleyel Theatre and in other French auditoria

# DOUBLE SKIN FAÇADE

## THE FIRST EXAMPLE: STEIFF FACTORY in GIENGEN 1903



# DOUBLE SKIN FAÇADE



Fassadendetail

- 1 Kathedralglas 3 mm
- 2 Eisenwalzprofil 30x20 und 35x25 mm
- 3 Vertikalstütze des Haupttragwerks I-Profil
- 4 Befestigungsglasche für Vorhangfassade
- 5 Querträger 70x140 mm
- 6 Ausfachung Hourdis-Elemente
- 7 Ausgleichsschicht Zementestrich
- 8 Konterlattung
- 9 Föhrendielenboden

# DOUBLE SKIN FAÇADE



Otto Wagner, MAIN HALL, Post Office Savings Bank in Vienna in Austria, 1903



Moisei Ginzburg, Ignaty Milinis, Narkomfin, Moscow, 1928-30

# DOUBLE SKIN FAÇADE



Villa Schwob, La Chaux de Fonds 1916. Notice the large window pane above the garden entrance: this was a double glass with an intermediate radiator system

## THE ZUYEV WORKERS CLUB

ILYA GOLOSOV

1926



The Zuyev Workers Club. Ilya Golosov, 1926. A precedent of double skin glazed walls in Moscow before the Centrosoyuz.

# DOUBLE SKIN FAÇADE



Le Corbousier and Nikolai Kolli,  
Centrosoyuz, Moscow, 1928-1936

The Centrosoyuz. The main glazed walls are double glass walls with no intermediate heating system.



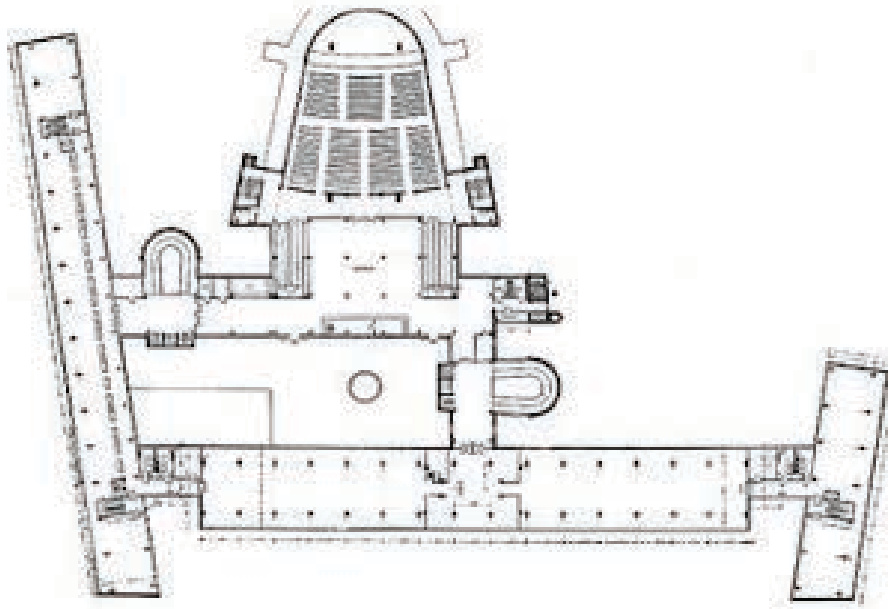


UNIVERSITA'  
DEGLI STUDI  
FIRENZE  
Scuola di  
Architettura



INTERNATIONAL COURSE ON  
ARCHITECTURAL DESIGN

## VENTILATED WALL



## VENTILATED WALL



The South facade of the Cité de Refuge building right after completion in 1933 (left). The sealed double glazed facade was a complete failure roasting the occupants during the summer. In the second version (right), after the building was bombed during the II World War, Le Corbusier abandoned his uncompromising approach and used passive solutions like brises soleil and sliding windows



**Le Corbu, Immeuble Clarté, 1930-32 Geneva**

## STRATEGIES AND TECHNIQUES OF:

- Screening
- Roofing

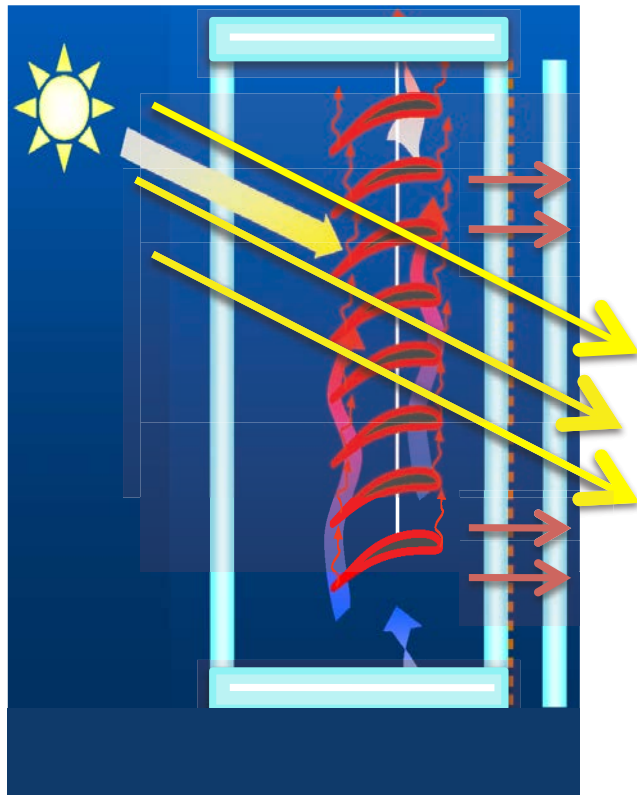


## MORE ON:

- Adapting and kinetic devices
- Parametric envelopes
- Green integration and nanotechnologies

# DOUBLE SKIN SHAFT

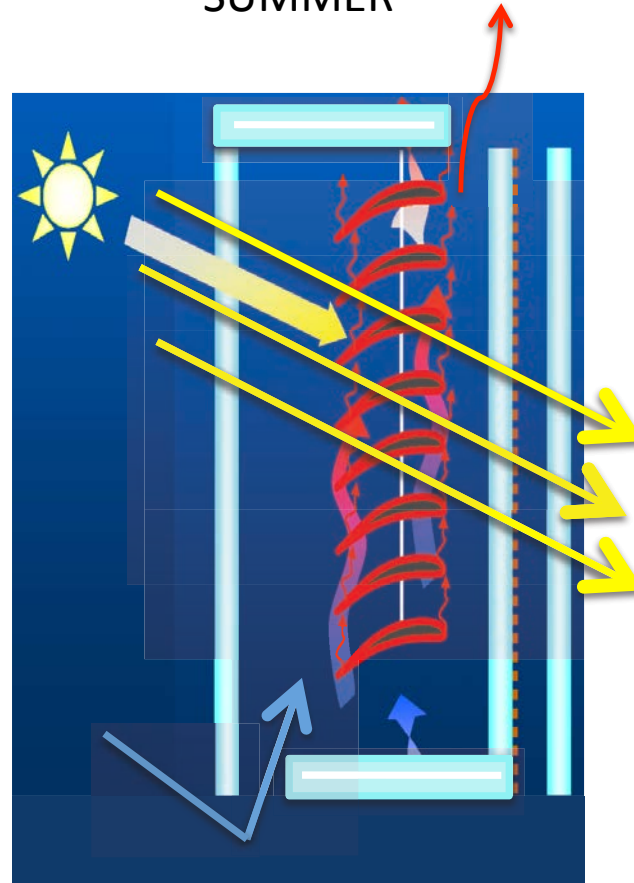
WINTER



GREENHOUSE EFFECT

HEATING

SUMMER



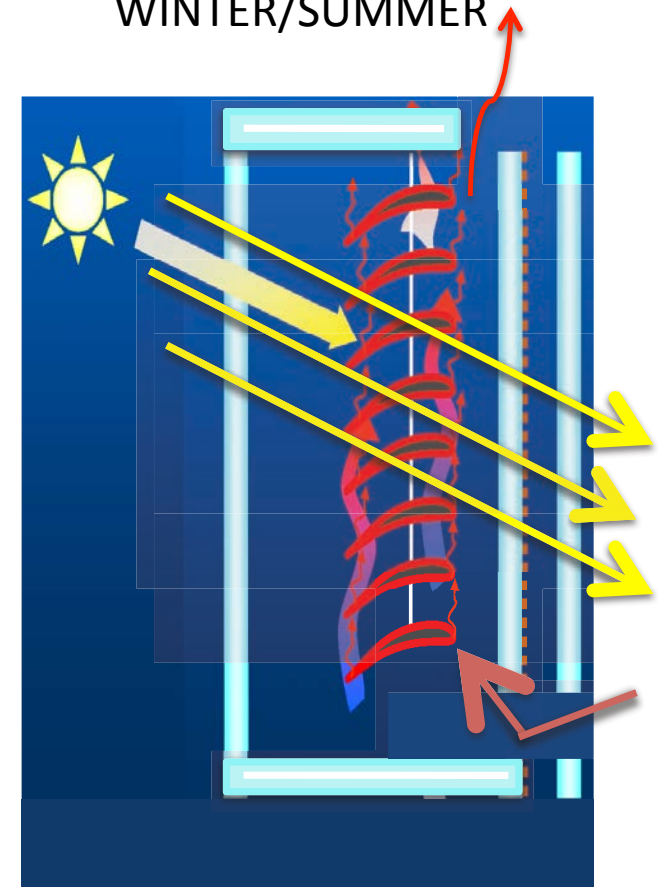
CHIMNEY EFFECT

REFRESHING

Night-time ventilation

During the summer and in the some climates where there is sufficient variation in diurnal and outdoor temperatures and a good prevailing wind, night-time ventilation can be used to cool down the thermal mass of the building interior, reducing air-conditioning loads. Heat gains generated during the day

WINTER/SUMMER



CLEANING  
(exhausted air)

## What is a high-performance commercial building façade?

the role of glazing systems in dynamic and responsive facades that provide the following functionality:

- Enhanced sun protection and cooling load control while improving thermal comfort and providing most of the light needed with daylighting;
- Enhanced air quality and reduced cooling loads using natural ventilation schemes employing the façade as an active air control element;
- Reduced operating costs by minimizing lighting, cooling and heating energy use by optimizing the daylighting-thermal tradeoffs;
- Improved indoor environments leading to enhanced occupant health, comfort and performance.

# DOUBLE SKIN FAÇADE

## ADVANTAGES

Advantages mentioned by author	Oesterle et al., (2001)	Compagno, (2002)	Claessens et al.	Lee et al., (2002)	B.B.R.I., (2002)	Arons, (2000)	Faist, (1998)	Kragh, (2000)	Jager, (2003)
Lower construction cost (comparing to electrochromic, thermochromic photo-chromic panes)	√								
Acoustic insulation	√			√	√	√	√	√	√
Thermal insulation during the winter	√	√		√	√		√	√	
Thermal insulation during the summer	√	√		√			√	√	
Night time ventilation	√	√	√	√		√			
Energy savings and reduced environmental impacts						√			
Better protection of the shading or lighting devices	√	√		√					√
Reduction of the wind pressure effects	√	√	√						√
Transparency – Architectural design					√	√	√		√
Natural ventilation	√	√		√		√	√		√
Thermal comfort – temperatures of the internal wall	√	√		√	√	√	√	√	
Fire escape	√								
Low U-Value and g-value		√				√		√	

## DISADVANTAGES

Disadvantages mentioned by author	Oesterle et al. (2001)	Compagno (2002)	Claessens et al.	Lee et al. (2002)	B.B.R.I. (2002)	Arons (2000)	Faist (1998)	Kragh, (2000)	Jager (2003)
Higher construction costs	√				√	√			√
Fire protection	√				√				√
Reduction of rentable office space	√								√
Additional maintenance and operational costs	√		√		√				√
Overheating problem	√	√			√		√		√
Increased air flow speed					√				
Increased weight of the structure			√						√
Daylight	√								
Acoustic insulation	√				√				√

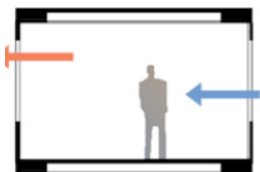
## NATURAL VENTILATION



Single-sided, high opening:  $D \leq 2H$   
With a single-sided, high level opening, ventilation is generally effective to room depths of up to 10 ft or less than two times the room height.



Single-sided, high and low openings:  $D \leq 2.5H$   
With two openings located at the top and bottom level of the window, ventilation can be effective up to 30 ft or less than 2.5 times the room height. The higher window element can be left open for general ventilation while the occupant can maintain control over the lower window(s).



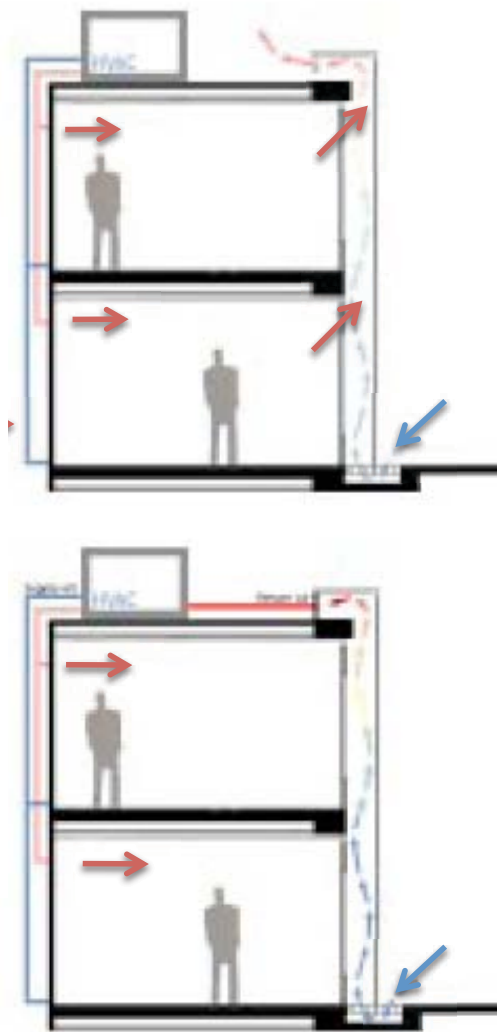
Cross ventilation:  $D \leq 5H$   
When the room has windows on opposite sides, cross ventilation is effective up to 40 ft of the room depth or five times the room height.

## MECHANIC VENTILATION

Natural ventilation can be introduced in a variety of ways: 1) with *operable windows*, ventilation can be driven by wind or thermal buoyancy (or stack effect) to ventilate a single side of a building or to cross ventilate the width of a building; 2) *stack-induced ventilation* uses a variety of exterior openings (windows in addition to ventilation boxes connected to underfloor ducts, structural fins, multi-storey chimneys, roof vents, etc.) to draw in fresh air at a low level and exhaust air at a high level and 3) *atria* enables one to realize a variant of stack ventilation, where the multi-storey volume created for circulation and social interaction can also be used to ventilate adjacent spaces.

With single-sided ventilation using operable windows, there are general rules of thumb used to estimate the effective depth of ventilation. With clerestory windows, single-sided ventilation is generally effective up to a room depth of 10 feet, or less than two times the room height. For windows with separate upper and lower openings, ventilation can be effective up to a room depth of 30 feet, or less than 2.5 times the room height. The upper window element can be left open for general ventilation while the lower can be controlled by the occupant. With cross-ventilation, where a zone has windows on opposite sides, ventilation can be effective up to 40 ft of the room width or less than five times the room height.

The type of window affects the degree of resistance to inflowing air and therefore ventilation potential. Sliders can provide an 100% unobstructed opening while a bottom-hung tipped casement may only provide a 25% unobstructed opening. Screens or mesh used to exclude birds and insects also reduce ventilation potential. Ventilation through a double-skin façade, as previously discussed, can also occur. Windows may be operated manually or with mechanized arms, similar to those used on HVAC ventilation systems or fire control shutters. To promote user satisfaction, one should allow the automatic control system to be overridden by the occupant.

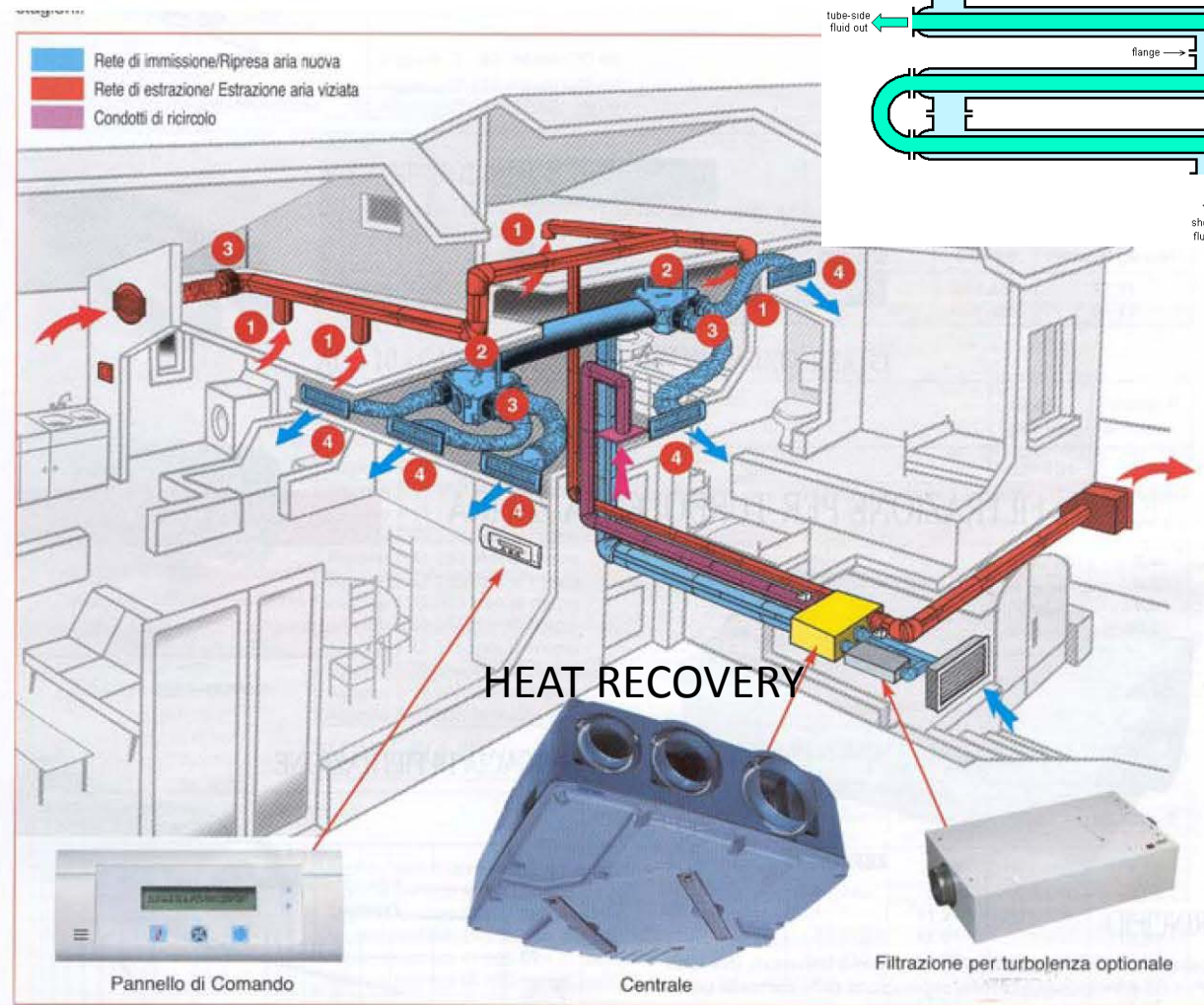


Heat extraction (above)

Heat recovery (below)



## Imp. autoregolabile: doppio flusso con recupero di calore termodinamico



## Impianto VMC per le abitazioni collettive

VENTIL

### Doppio flusso con recupero statico condominiale

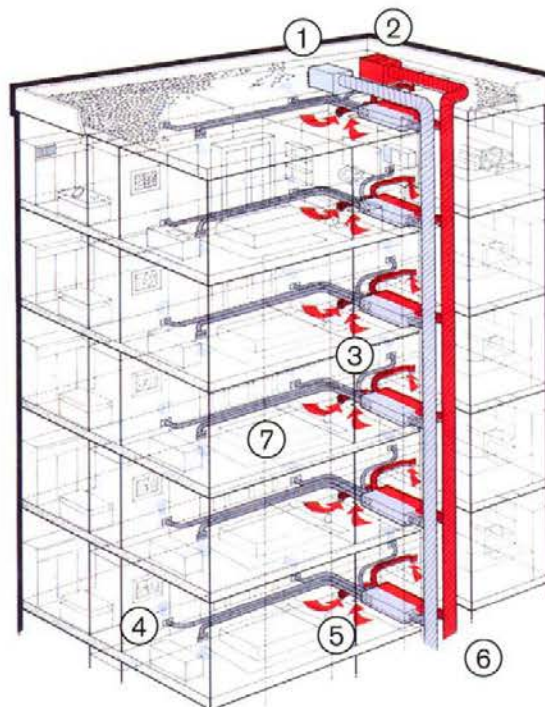
L'applicazione dei sistemi di VMC nell'edilizia condominiale prevede la centralizzazione dell'aria di rinnovo filtrata come la centralizzazione dell'estrazione. La regolazione della portata avviene con il sistema autoregolabile. Gli scambiatori di calore rimangono autonomi per una gestione in base alla reale produzione di ogni singola abitazione.



Ventilatore di immissione con filtrazione



### Condotti ovali per interni



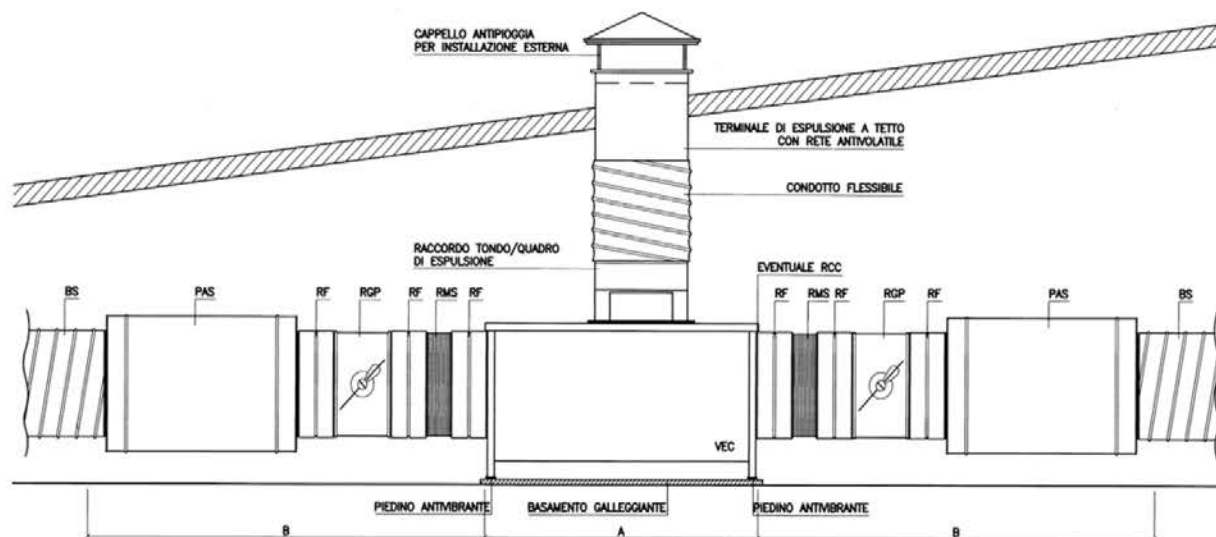
- 1 - Ventilatore di immissione centralizzato
- 2 - Ventilatore di estrazione centralizzato
- 3 - Recuperatore di calore autonomo
- 4 - Terminale di immissione aria nuova
- 5 - Terminale di estrazione
- 6 - Canalizzazioni principali
- 7 - Condotti di distribuzione interna

# NATURAL & MECHANICAL VENTILATION



## Impianto VMC per le abitazioni collettive: schema di collegamento al ventilatore

### VENTILATORI SERIE: C.VEC - VEC GRANDE - VEC HIGRO



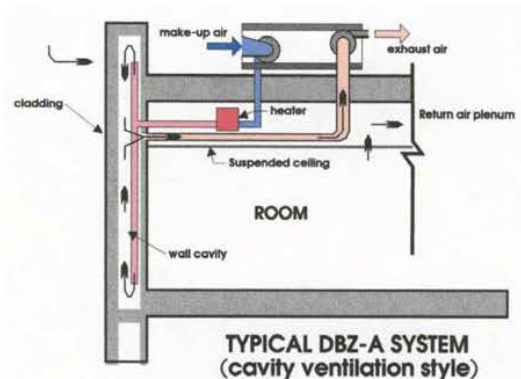
	B	B+RCC max
DN 160	1265	1615
DN 200	1265	1615
DN 250	1265	1615
DN 315	1485	1835
DN 355	1495	1845
DN 400	1616	1966
DN 450	1600	1950
DN 500	1600	1950
DN 560	1600	1950
DN 630	1600	1950

C. VEC-VEC GRANDE-VEC HIGRO	A
C. VEC 750 R	505
C. VEC 1500 R	710
C.VEC 2500 R	780
VEC 271	1180
VEC 321	1180
VEC 382	1411
VEC 452	1411
C. VEC 240 H	710

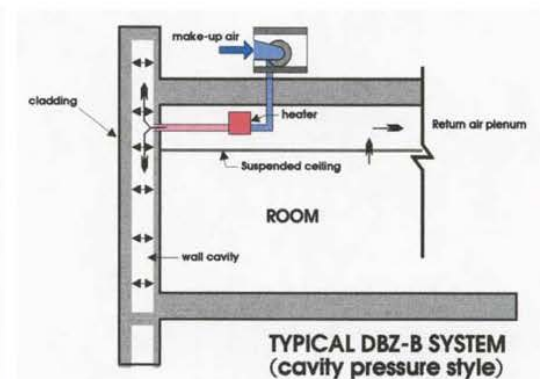
VEC	=	VENTILATORE DI ESTRAZIONE
RF	=	RACCORDO FEMMINA
PAS	=	SILENZIATORE CIRCOLARE
RGP	=	SERRANDA DI TARATURA A FARFALLA
RMS	=	RACCORDO ANTIMBRANTE
BS	=	CONDOTTO SPIRALATO
RCC	=	RIDUZIONE CONICA CONCENTRICA

## THE DYNAMIC BUFFER ZONE: A CANADIAN RESEARCH RESPONSE

Canadian researchers, under the original direction of the late Kirby Garden, have developed a variation of the classic glazed double façade system. The initial application for this system is in the retrofit of existing (historic) buildings with exterior uninsulated masonry cavity walls. In this system, dry conditioned air is forced into and out of the interstitial cavity spaces by means of a dedicated mechanical system in a way to constantly ensure positive pressure within the cavities relative to their environments. This eliminates moisture accumulation from either the interior or exterior sources within the assemblies. These assemblies can then be maintained at relatively constant temperatures, distanced from the dewpoint, minimize freeze thaw damage and maintain comfort levels on the interior.

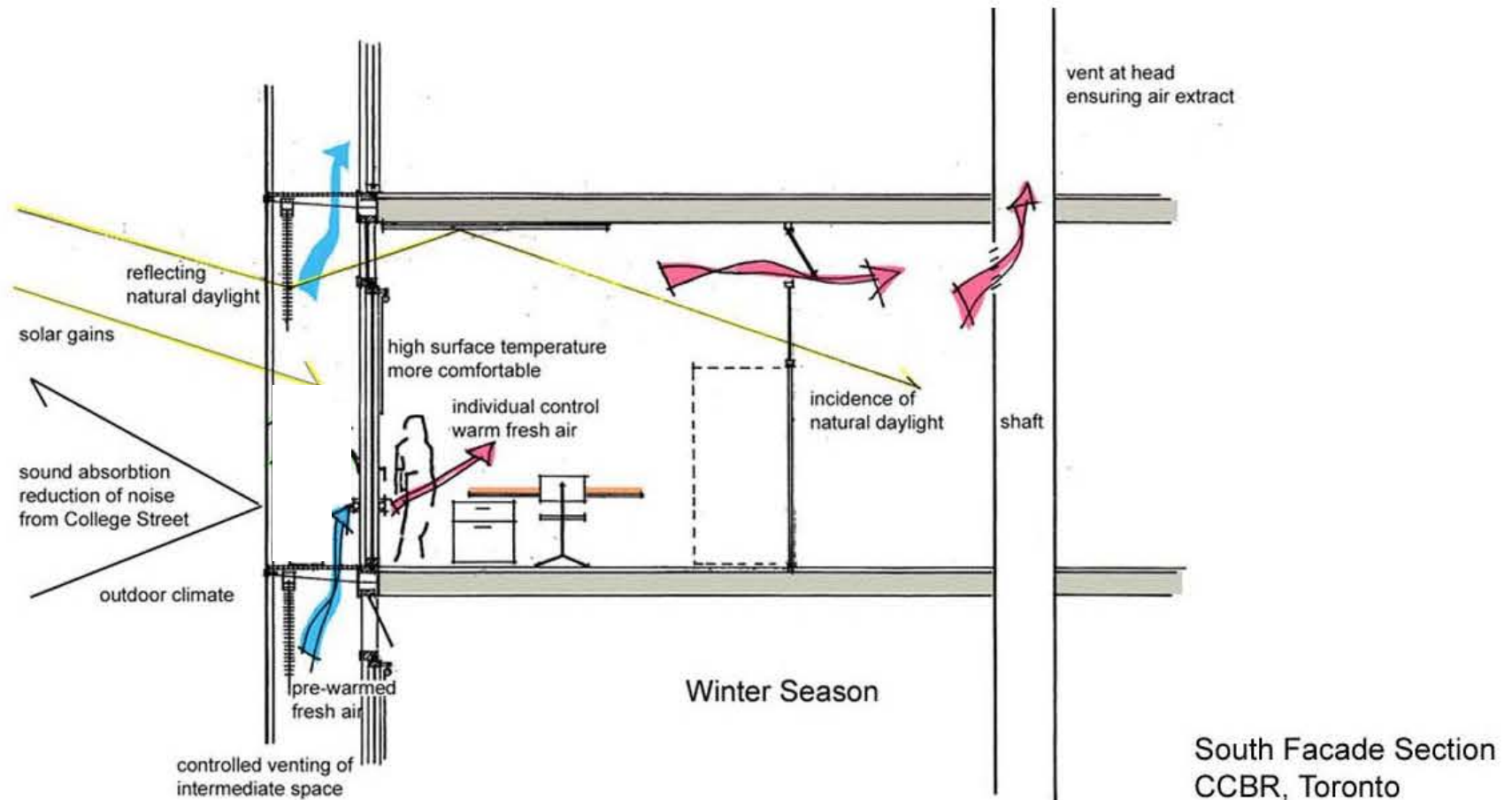


**Figure 10:**  
DBZ with ventilated cavity



**Figure 11:**  
DBZ with pressurized cavity

In the ventilated cavity system [Fig. 10] the construction cavities are ventilated with dry outdoor air and pressure relieved/controlled through a return or exhaust system. In the pressurized cavity system [Fig. 11] the construction cavities are pressurized slightly above the indoor pressure of the building with preheated outdoor air without a pressure relief or return air system. The pressurized system has been more successfully applied partly as a result of its less complicated/equipment intensive design.[11]



**Figure 5:**  
**Winter condition of the south façade of the CCBR at University of Toronto**

Windows on the interior façade can be opened, while ventilation openings in the outer skin moderate temperature extremes within the façade. The use of windows can allow for night-time cooling of the interior thereby lessening cooling loads of the building's HVAC system. For sound control, the openings in the

# DOUBLE SKIN VENTILATION SCHEME



## GSW Headquarters

Building: Gemeinnützige Siedlungs-und Wohnbaugenossenschaft mBH (GSW) Headquarters

Location: Berlin, Germany

System: Double-skin façade

Architect: Sauerbruch Hutton Architekten

Completion: 1995-1999

Project Description: 22-storey, 11-m wide office building with cross ventilation and a double-skin thermal flue on the west-facing façade.



Exterior views of the vertical louvers on the west facade.



Exterior and interior view of the east triple-glazed facade system.

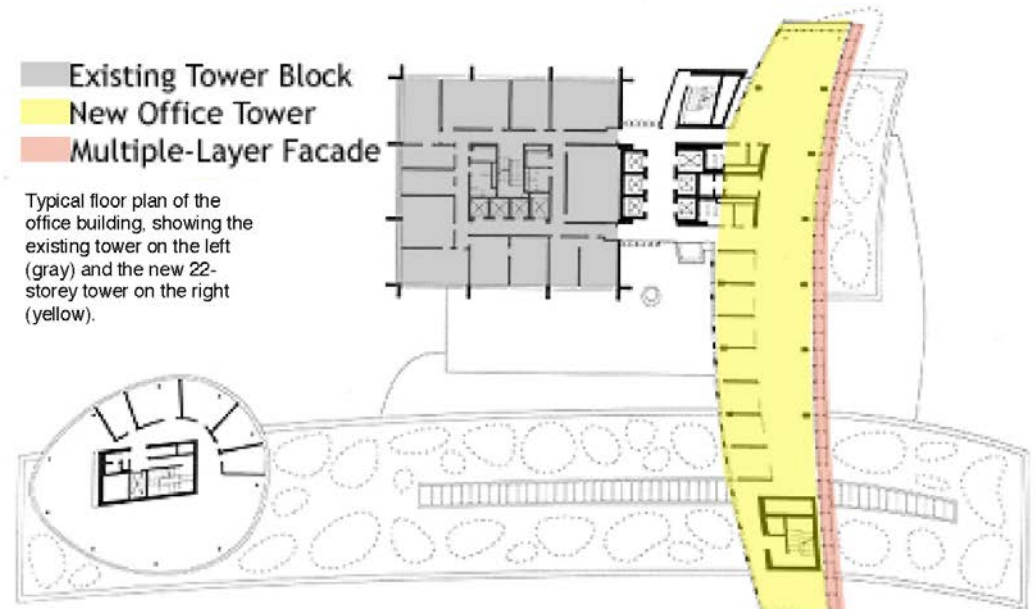
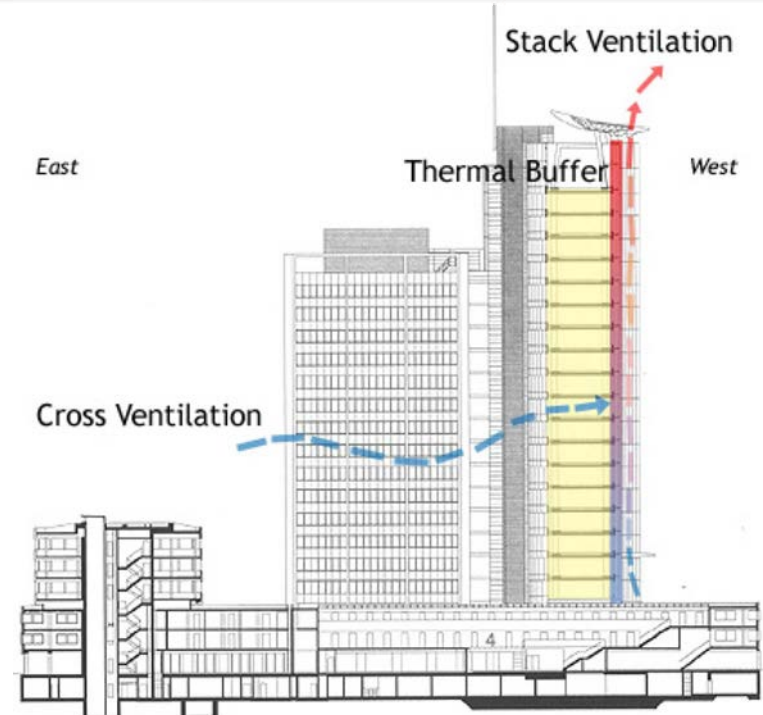
This 11-m wide office building allows for cross ventilation. The east façade consists of automatically and manually-operated triple-glazed windows with between-pane blinds. Louvered metal panels also occur on the east façade to admit fresh air independently from the windows. The west façade consists of a double-skin façade with interior double pane windows that are operated both manually and automatically and a sealed 10-mm exterior glazing layer. The interstitial space is 0.9 m wide. Wide, vertical, perforated aluminum louvers located in this interstitial space are also automatically deployed and manually adjustable. The louvers can be fully extended to shade the entire west façade.

Outside air admitted from the east façade provides cross ventilation to the opposing west façade. The prevailing window direction is from the east. The west façade acts as a 20-storey high shaft inducing vertical airflow through stack effect and thermal buoyancy. Where partitioned offices occur, sound-baffled vents permit airflow across the building.

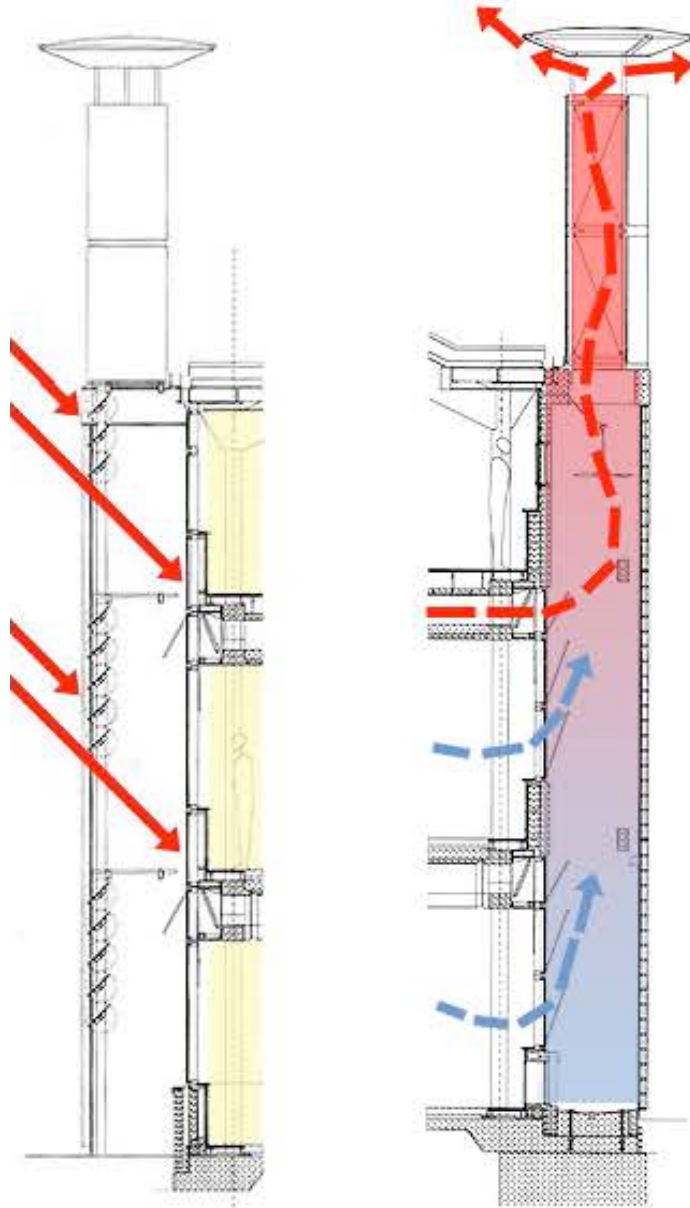
During the heating season, the air cavity between multi-layer facade acts as a thermal buffer when all operable windows are closed. Warm air is returned to the central plant via risers for heat recovery. Fresh air is supplied from the raised floor system. Radiant heating and cooling are provided. Thermal storage in the ceiling and floor was created using exposed concrete soffits and a cementitious voided screed system. Various building systems such as lighting and diffusers are either integrated into the soffit or into the voided screed.

For all-glass facades, solar chimneys are essentially the glazed manifestation of a stack-induced ventilation strategy. A glass, multi-storey vertical chimney (shaft) is located on the south façade of the building. Operable windows connect to this vertical chimney. Similar to the heat extraction concept described above for double-skin facades, solar heat gains absorbed within the chimney causes hot air to rise, inducing cross ventilation from the cooler north side of the building. Mechanical ventilation can be used to supplement this ventilation if natural means are insufficient.

Stack-induced ventilation through atria work using the same principle as a solar chimney but can serve more functions. Atria can be situated in the core of the building or form a single-, double-, or triple-sided, all-glass, multi-storey zone at the exterior of the building. The roof is typically glazed. Atria can be used to provide daylight to adjacent spaces and can act as a thermal buffer during the winter season.



# DOUBLE SKIN SHAFT



Cross section through the glazed facade (left) and the ventilation stack (right)



Exterior view of south facade (top)

Floor plan with cellular offices on the north side and open plan on the south side (bottom)

## Building Research Establishment

Building: Environmental Building, Building Research Establishment

Location: Garston, UK

System: Operable solar shading and stack ventilation

Architect: Fielden Clegg

Completion: 1991 / 1997

Project Description: Low-rise, low-energy office building for 100 people with stack ventilation, cross ventilation, and operable shading systems on the south building facade.

A key feature of this building is the integration between natural ventilation and daylighting strategies. The floor plan (shaded in yellow in the picture to the left) is divided into open-plan and cellular offices allowing cross ventilation in the open plan arrangement while the 4.5-meter-deep cellular offices are located on the north side with single-sided natural ventilation. A shallow open-office plan is coupled to a highly glazed facade. A wave-form ceiling structure is used. At the high point of the wave, a clerestory window allows daylight to effectively penetrate the space. A duct providing space conditioning and ventilation was placed within a hollow core at the low point of the wave-form structure.

For shading, translucent motorized external glass louvers (Colt International) are controlled by the building management system and can be overridden by the occupants. The glass louvers can be rotated to diffuse direct solar or to a horizontal position for view.

A stack ventilation system was designed as an alternative ventilation strategy for the open plan offices during extreme cooling conditions. Vertical chimneys were designed to draw hot air through the duct in the wave-form structure as well as through bottom-hung, hopper, etched windows. The exterior of the stacks are glazed with etched glass blocks, allowing daylight admission. Low-resistance propeller fans were mounted at the top-floor level, to provide minimum ventilation and to flush internal heat gains during the night.

### Reference

Edwards, B. editor. 1998. Green buildings pay. London: E&FN Spon.



# HYBRID SYSTEM VENTILATION

## Hybrid System:

The hybrid system combines various aspects of the above systems and is used to classify building systems that do not "fit" into a precise category. Such buildings may use a layer of screens or non-glazed materials on either the inside or outside of the primary environmental barrier. The Tjibaou Center in New Caledonia by Renzo Piano may be used to characterize this type of Hybrid system.

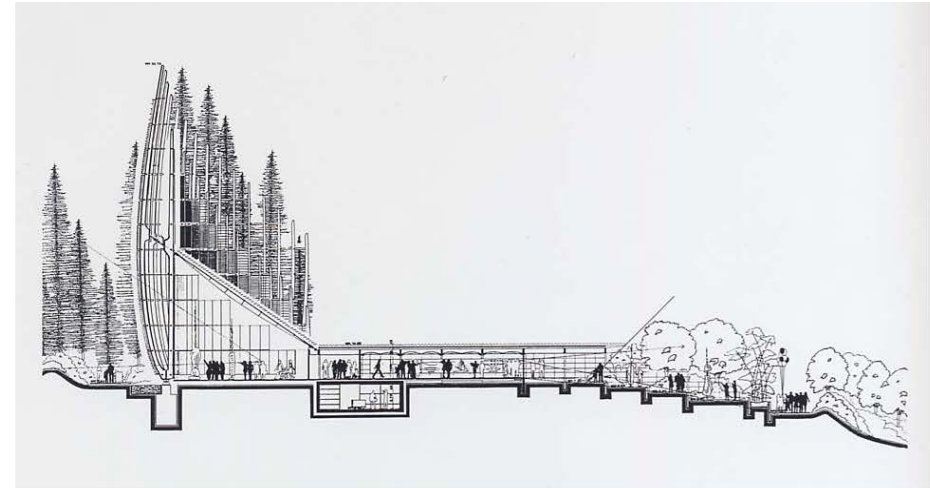


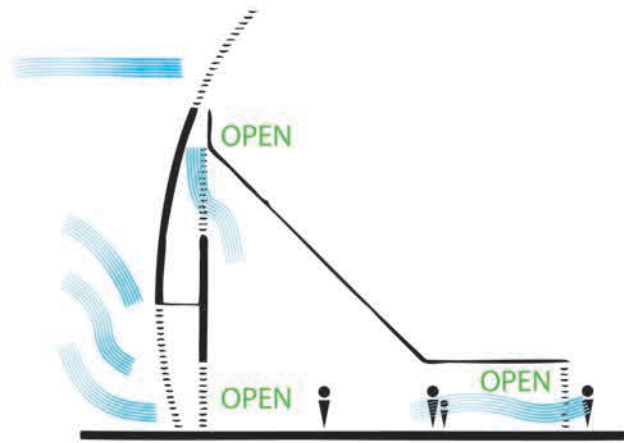
Figure 6:

Cross section of the Tjibaou Center by Piano illustrating the use of a hybrid system

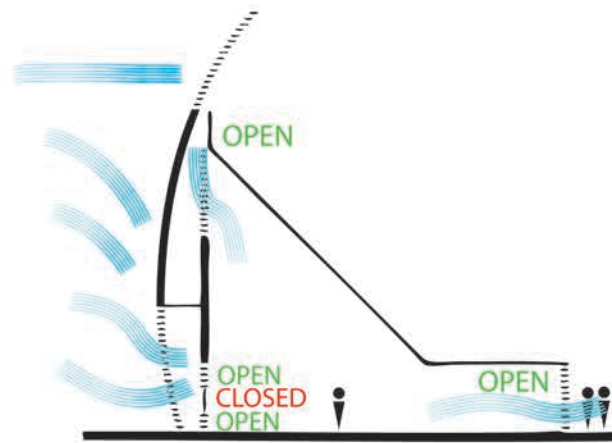


# HYBRID SYSTEM VENTILATION

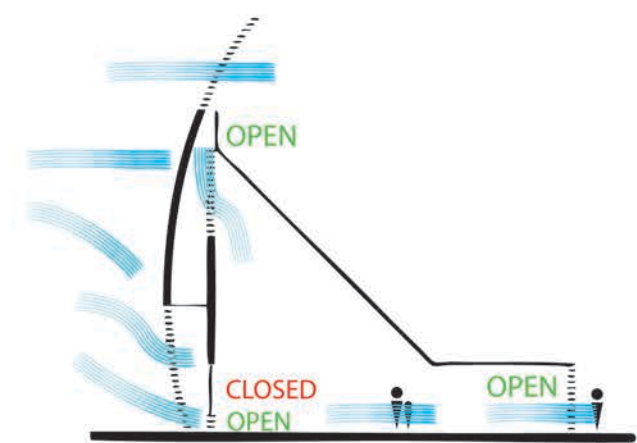
VENTILATION DUE TO WIND FORCES | pressure differential created by incoming force of wind



STILL AIR OR LIGHT WIND

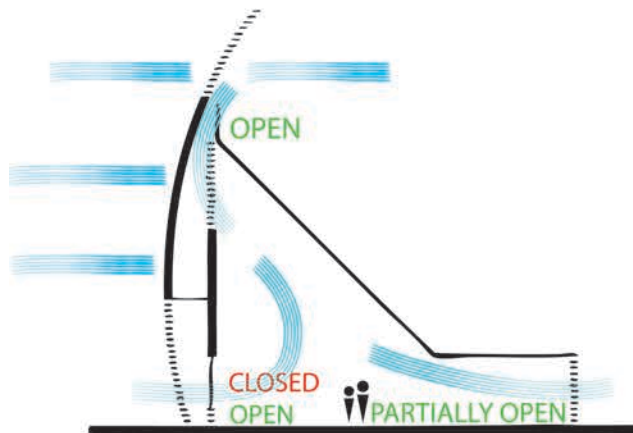


LIGHT WIND



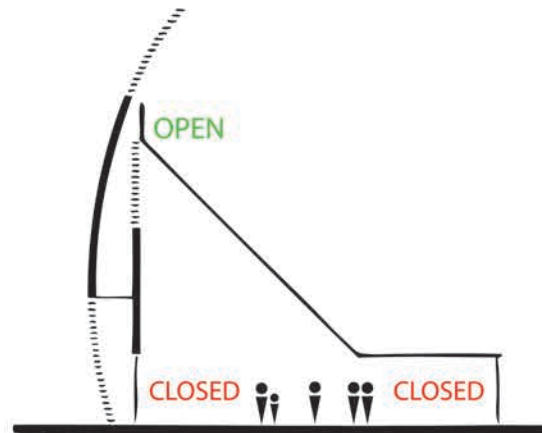
MODERATE WIND & LIGHT BREEZES

ventilation relies solely upon wind forces | the height of the building is not utilized



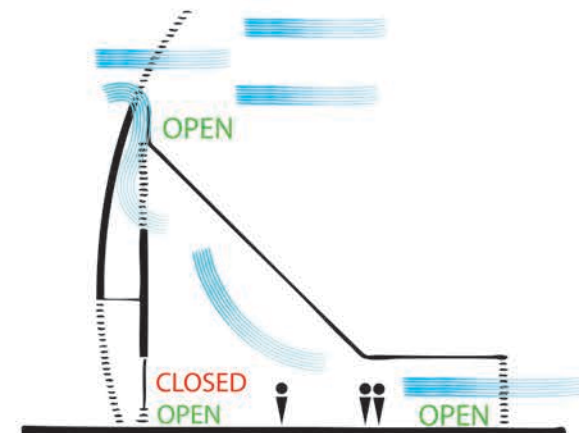
STRONG WIND

ventilation relies upon convection & the negative pressure created by the wind



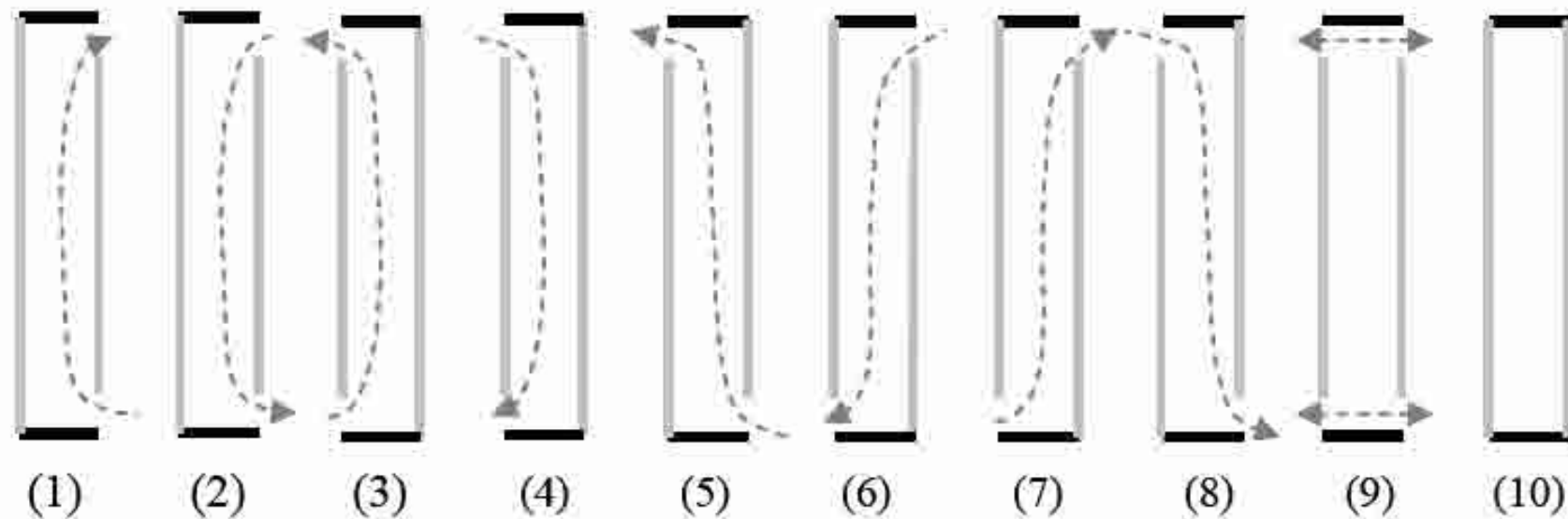
CYCLONE

all louvred openings are closed



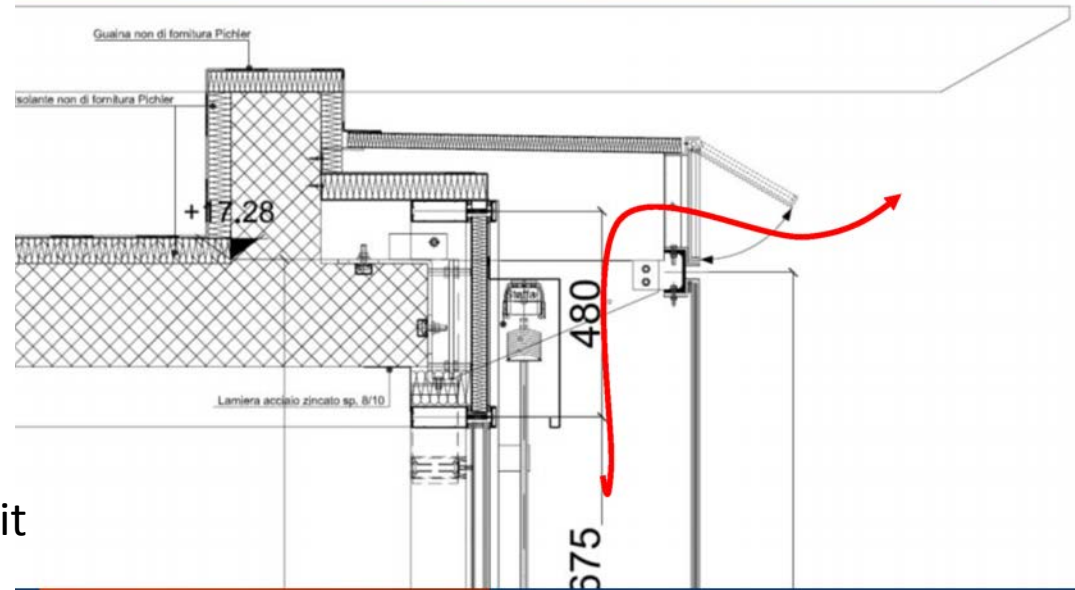
WIND FROM OPPOSITE DIRECTION

wind coming across lagoon rather than bay  
utilization of wind ventilation & stack ventilation

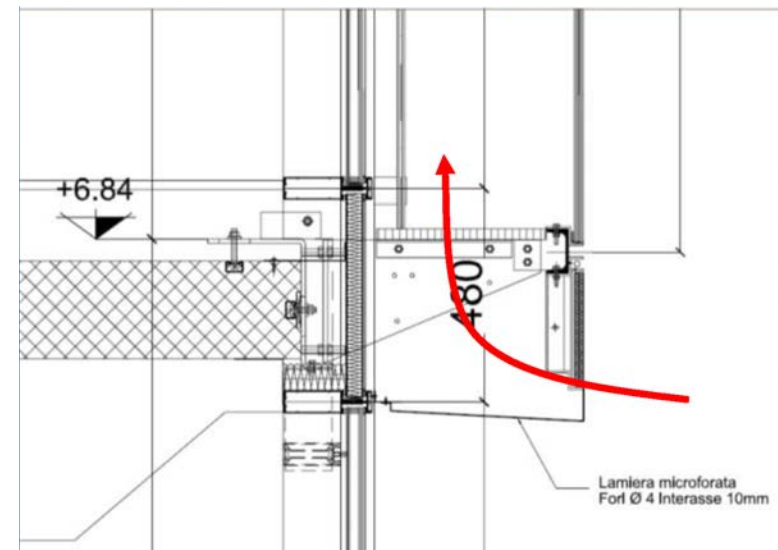


*Figure 4.11 Ten air flow regimes (louver slats not drawn for clarity), Park, et al. (2003).*

# DOUBLE SKIN – LOUVER DETAILS



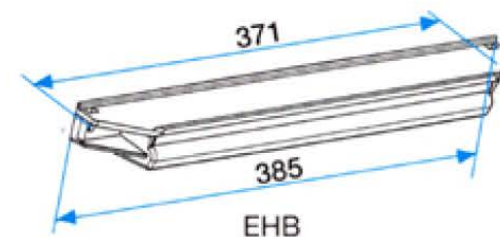
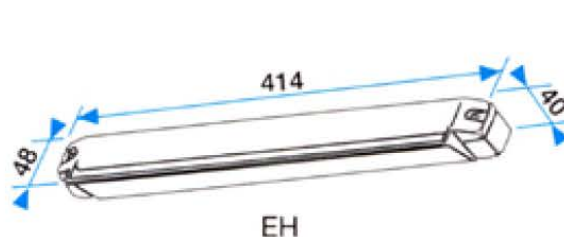
heated air exit



external air entrance

## Sistemi di VMC: abbattimento acustico di facciata

### Controvento insonorizzato

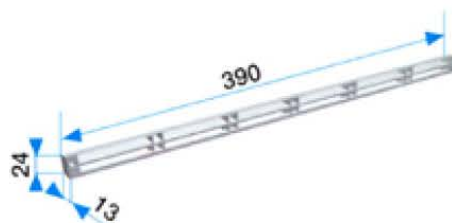


#### APPLICAZIONE

- Montaggio all'esterno del serramento o della manichetta a muro.
- Oltre ad evitare l'ingresso dell'acqua aumenta l'isolamento acustico
- Utilizzato in abbinamento con gli ingressi aria insonorizzati consente un elevato livello di tenuta al rumore.

R4	Descrizione	dB	Colore
	Controvento Insonorizzato 30 EH	+ 2	Bianco
			Alu
	Controvento Insonorizzato 22 EH	+ 2	Bianco
			Alu
	Controvento Insonorizzato EHB	+ 4	Bianco
			Marrone
			Frassino

### Controvento Standard



Controvento standard

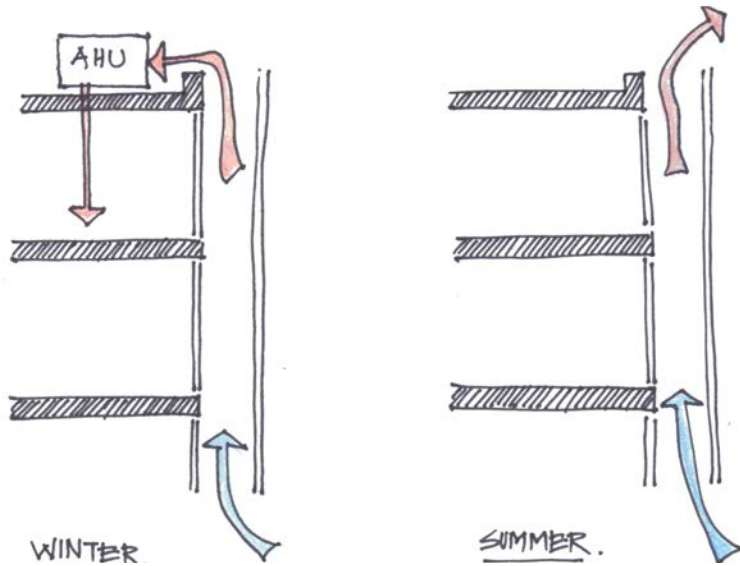
#### APPLICAZIONE

- Montaggio all'esterno del serramento o della manichetta a muro.
- Evita l'ingresso dell'acqua a vento.

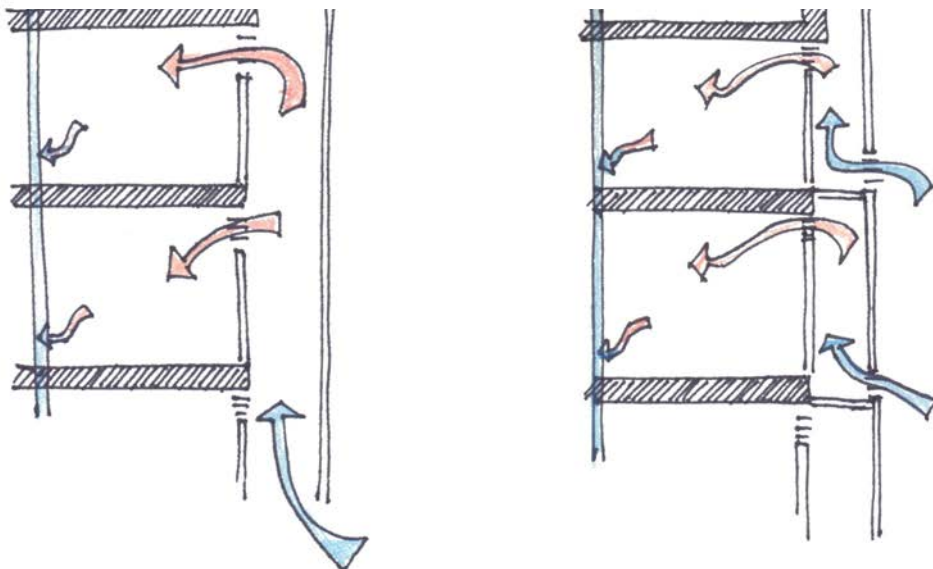
R4	Descrizione	Colore
	Controvento standard 30	Bianco
		Marrone
		Frassino
		Nero
		Alu

## PRE-HEATING / REFRESHING SYSTEM

Double Skin Façade as a central direct pre-heater of the supply air

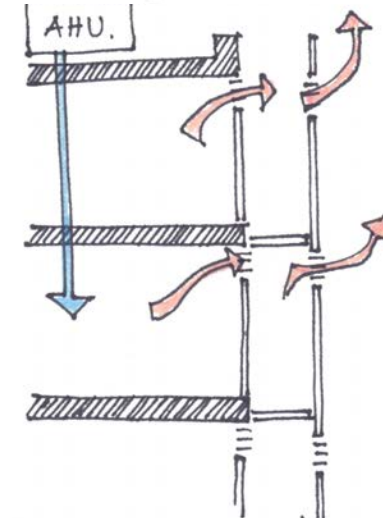


Double Skin Façade as an individual supply of the preheated air

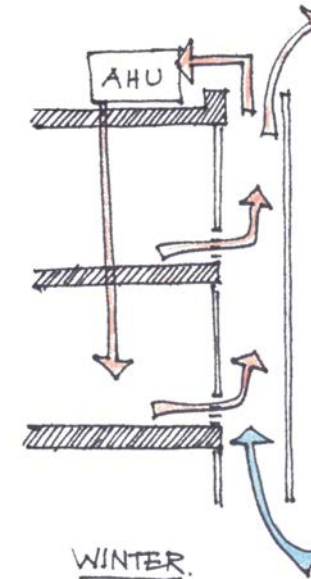


## EXHAUST DUCTING SYSTEM

Double Skin Façade as an exhaust duct



Double Skin Façade as a central exhaust duct for the ventilation system



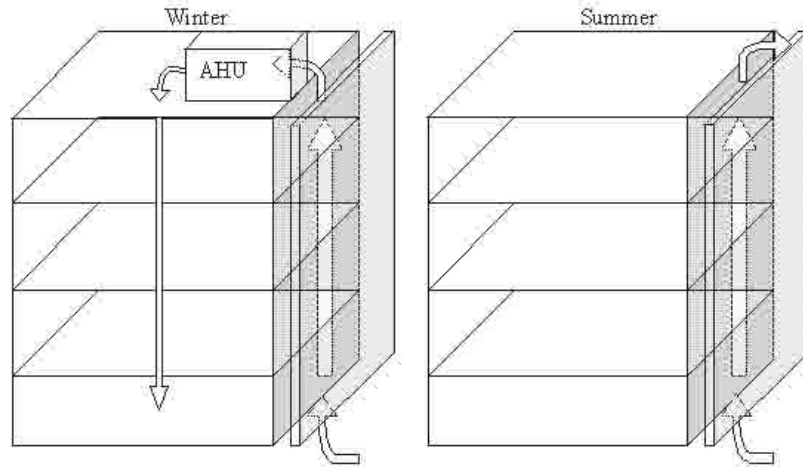


Figure 4.1 Double Skin Façade as a central direct pre-heater of the supply air.

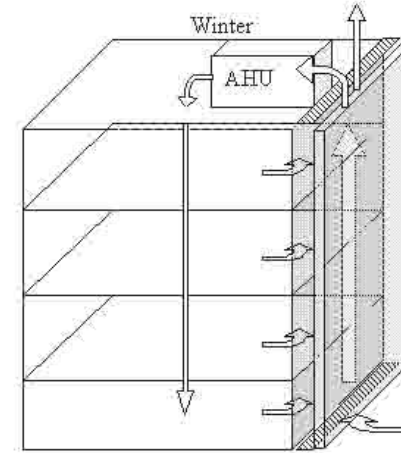


Figure 4.4 Double Skin Façade as a central exhaust duct for the ventilation system.

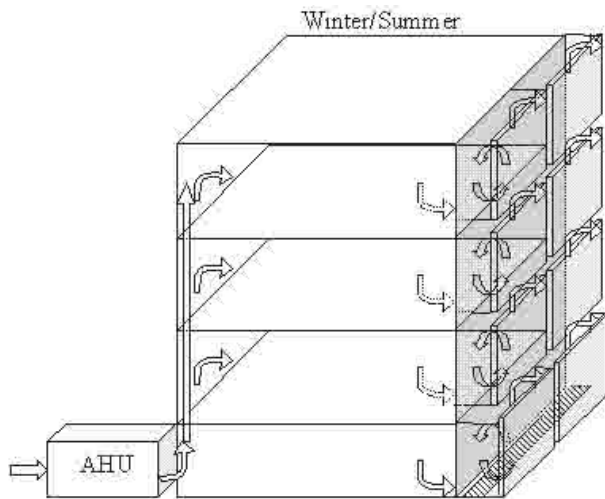


Figure 4.2 Double Skin Façade as an exhaust duct.

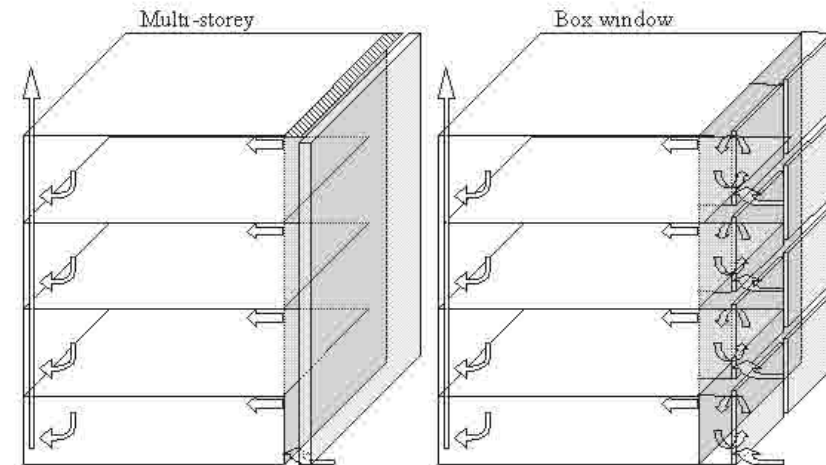
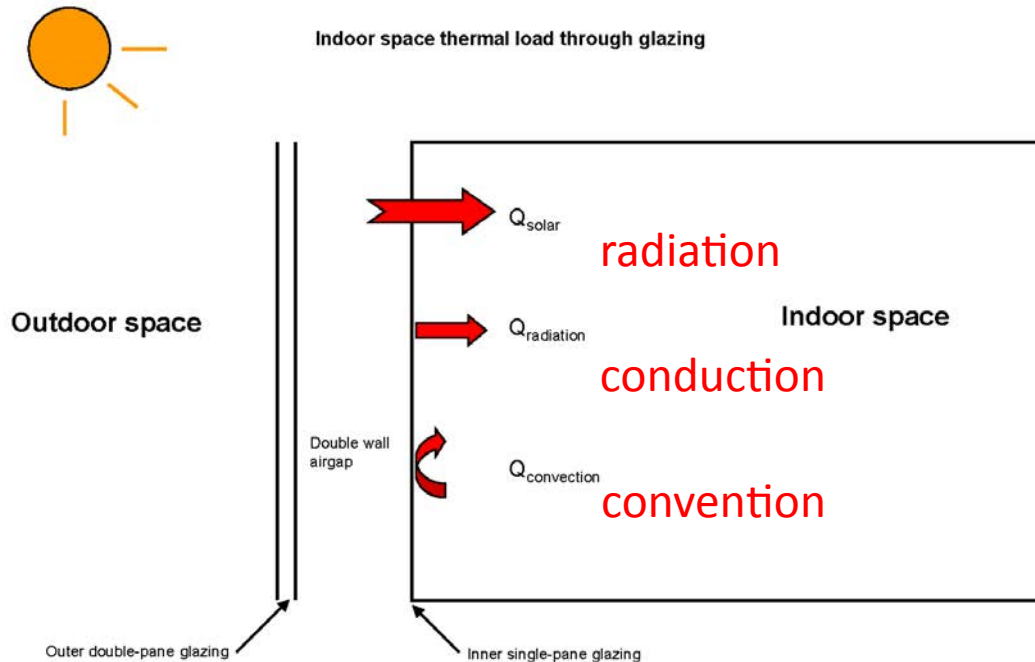


Figure 4.3 Double Skin Façade as an individual supply of the preheated air.

# SHAFT INTEGRATION



$$Q_{total} = Q_{solar} + Q_{radiation} + Q_{convection}$$

Where:

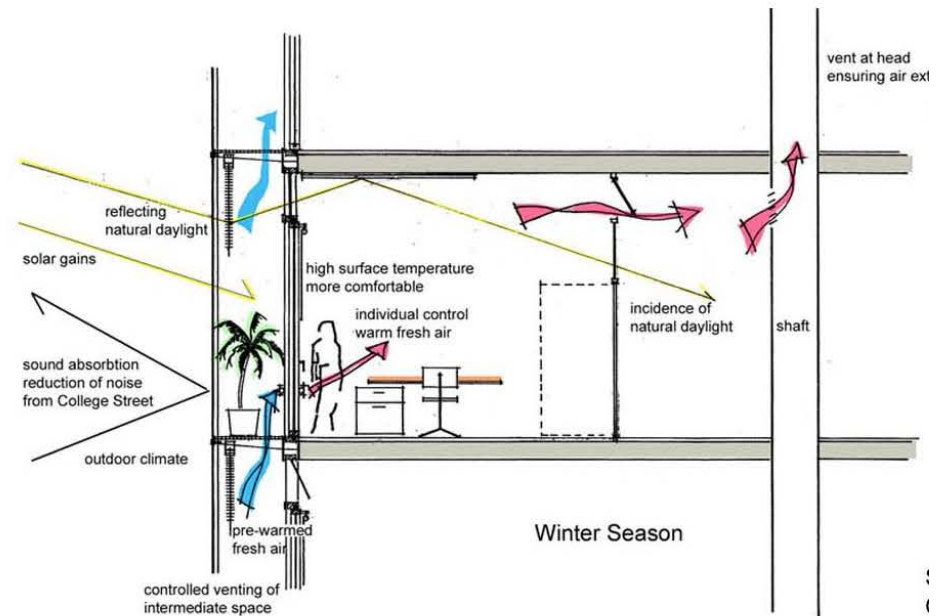
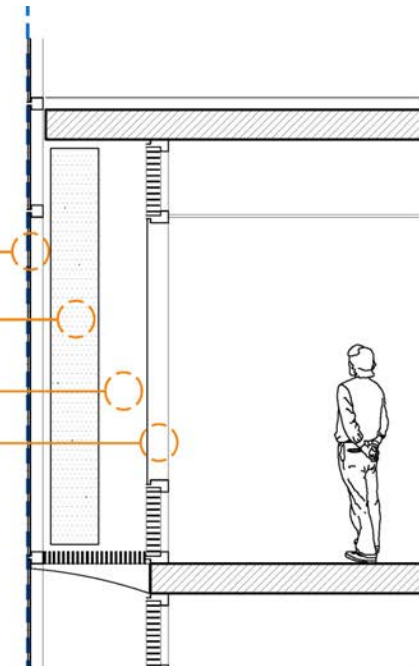
$Q_{total}$  is the total heat entering the indoor space through glazing.

$Q_{solar}$  is the solar heat entering the indoor space through glazing.

$Q_{radiation}$  is the heat entering the indoor space by thermal radiation from the glazing internal surface.

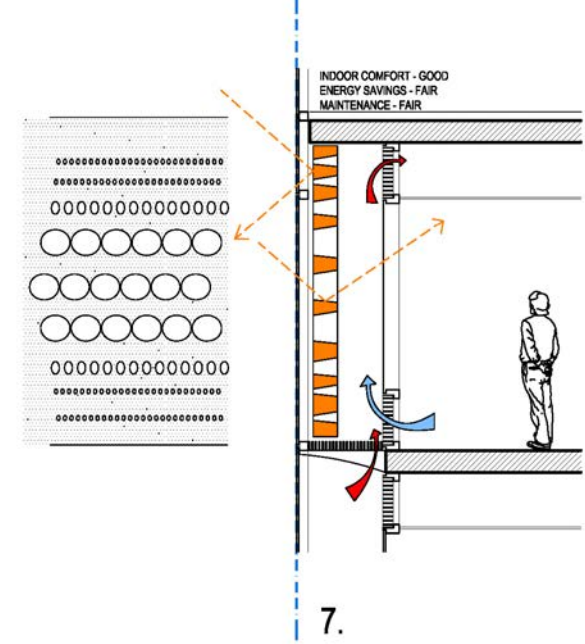
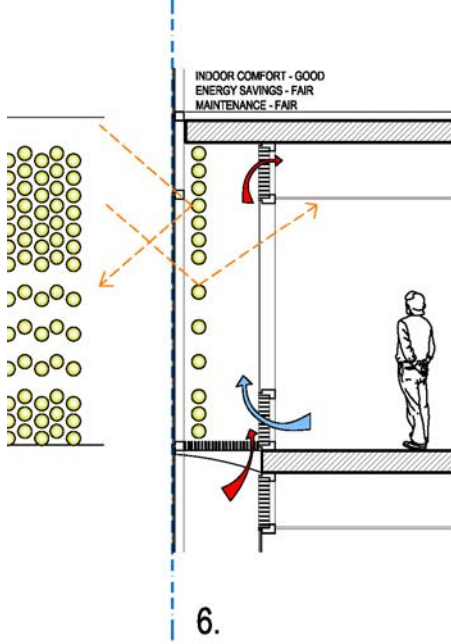
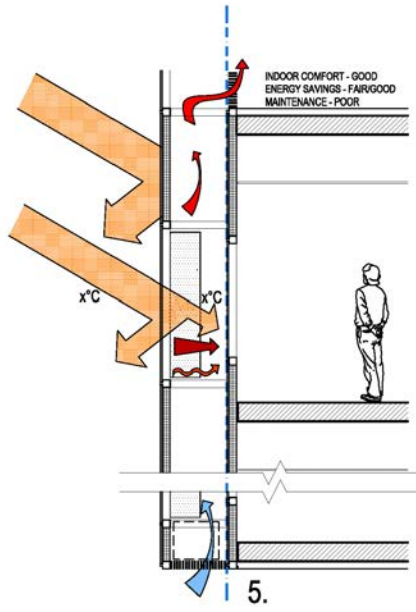
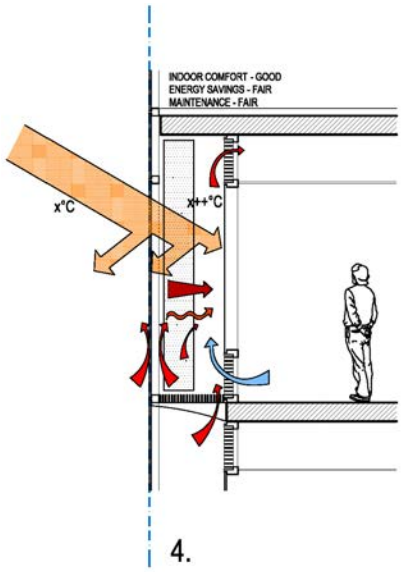
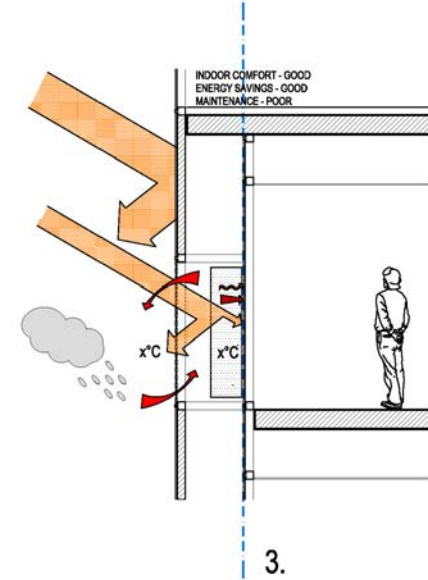
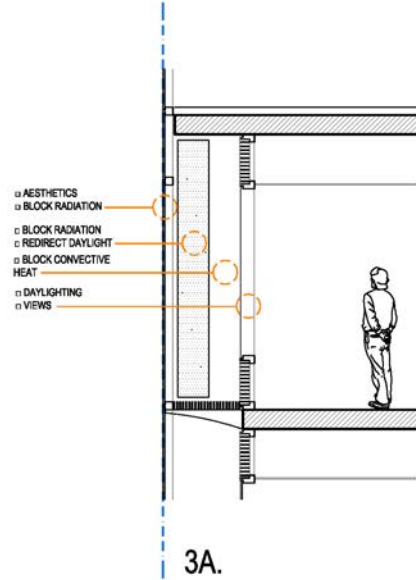
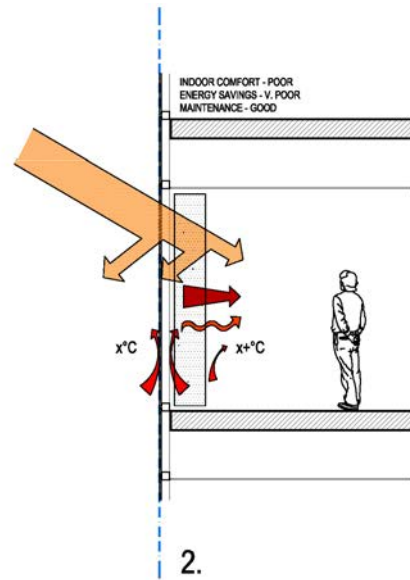
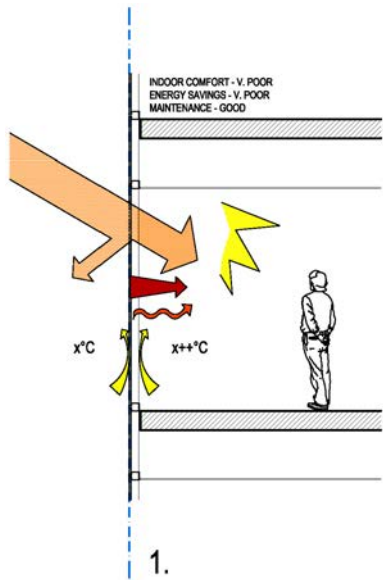
$Q_{convection}$  is the heat entering the indoor space by thermal convection from the glazing internal surface.

- AESTHETICS
- BLOCK RADIATION
- BLOCK RADIATION
- REDIRECT DAYLIGHT
- AESTHETICS
- BLOCK CONVECTIVE HEAT
- DAYLIGHTING
- VIEWS





# SHAFT INTEGRATION



## 2 Classification of Double Skin Façades

Different ways to classify Double Skin Façade Systems are mentioned in the literature. The systems can be categorized by the type of construction, the origin, destination and type of the air flow in the cavity, etc.

The Environmental Engineering firm of Battle McCarthy in Great Britain created a categorization of five primary types (plus sub-classifications) based on commonalities of façade configuration and the manner of operation. These are:

- Category A: Sealed Inner Skin: subdivided into mechanically ventilated cavity with controlled flue intake versus a ventilated and serviced thermal flue.
- Category B: Openable Inner and Outer Skins: subdivided into single story cavity height versus full building cavity height.
- Category C: Openable Inner Skin with mechanically ventilated cavity with controlled flue intake
- Category D: Sealed Cavity, either zoned floor by floor or with a full height cavity.
- Category E: Acoustic Barrier with either a massive exterior envelope or a lightweight exterior envelope.

Oesterle et al., (2001) categorize the Double Skin Facades mostly by considering the type (geometry) of the cavity. Very similar is the approach of Saelens (2002) and E. Lee et al. (2002) in “*High Performance Commercial Building Facades*”. The types are described below:

- Box window type: In this case horizontal and vertical partitioning divide the façade in smaller and independent boxes
- Shaft box type: In this case a set of box window elements are placed in the façade. These elements are connected via vertical shafts situated in the façade. These shafts ensure an increased stack effect.
- Corridor facade: Horizontal partitioning is realized for acoustical, fire security or ventilation reasons.

- Multi storey Double Skin Façade: In this case no horizontal or vertical partitioning exists between the two skins. The air cavity ventilation is realized via large openings near the floor and the roof of the building.

The BBRI, (2002) adds also another type of façade, the Louvers Facades. As it is described, “*with this kind of façade, the exterior skin is composed of motorized transparent rotating louvers. In closed position, these louvers constitute a relatively airtight façade. In open position, they allow an increased ventilation of the air cavity*”.

Uttu, (2001) classifies the Double Skin Façade systems in a similar way described below:

- Building-high double-skin façade: According to her, “*a building-high double-skin façade, the cavity is not separated at each storey; instead it extends over the whole height of the building. The basic idea of a building-high cavity is the following: air that accumulates at the top of the air space between the two layers is likely to get hot on sunny days. Openings in the outer skin and at the roof edge siphon out the warm air, while cooler replacement air is drawn from near the base of the building.*”
- Storey-High Double-Skin Façades: “*The storey high double-skin façades consists of air channels separated horizontally at each intermediate floor.*”
- Box Double-Skin Façades: “*Box double-skin façades are stockwise ventilated façades with horizontal partitions on each floor and vertical partition on each window. The inlet and outlet vents are placed at each floor. Hence the lowest degree of air heating and therefore the most effective level of natural ventilation is to be expected.*”

A type of “Diagonal Streaming of Air” ventilation configuration inside this type of cavity is described both by Uttu and the journal “Space Modulator”, (1999). “*In box double-skin façades, a special sash called a “fish-mouth” designed to admit and exhaust outside air is often built in between storeys. This “fish mouth” has air inlets and outlets. The outside air from the intake “fish-mouth” is warmed inside the double-skin and diagonally ascends to be exhausted from the outtake “fish mouth” at the neighbouring sash. If both the “fish mouths” are laid out vertically, a large part of the exhausted air would have been reabsorbed. This system also prevents fire from spreading to other levels.*”

- Shaft Façades: “*A shaft façade is a combination of a double skin façade with a building-high cavity and a double-skin façade with a storey-high cavity. The full-height cavity forms a central vertical shaft for exhaust air.*”

### Classification of Double Skin Façades

*On both sides of this vertical shaft and connected to it via overflow openings are storey-high cavities. The warmed, exhaust air flows from the storey high cavity into the central vertical shaft. There it rises, due to the stack effect and escapes into the open at the top. The buoyancy in the shaft supports this flow at the level of the lower floors in that as the trapped air is warmed it is drawn upwards”.*

Arons, (2000) describes two types of facades:

- *Airflow facades: a double façade that is continuous for at least one storey with its inlet at or below the floor level of one storey and its exhaust at or above the floor level above.*
- *Airflow window: a double leaf façade that has an inlet and outlet spaced less than the vertical spacing between floor and ceiling.*

More detailed, the author describes crucial parameters of the design the function and thus the classification of this system separating them to:

- primary identifiers
  - ✧ airflow patterns
  - ✧ building height
- secondary identifiers
  - ✧ layering composition,
  - ✧ depth of the cavity,
  - ✧ horizontal extend of cavity
  - ✧ vertical extend of cavity
  - ✧ operability
  - ✧ materials

Magali, (2001) divides the double skinned façades in two categories: A) Double Skinned Façade on several floors and B) Double skinned façade per floor. As she mentions, *“The difference between the categories (A) and (B) is that there is a horizontal partitioning into the air cavity, at each floor”.*

According to the author, each of these categories is divided into sub-categories. The distinction has been made between airtight or non-airtight façades *“the tightness of the façade is related with the possibility to open the windows”.*

### Classification of Double Skin Façades

- *Interactive Wall: “The principle of the interactive is much like that of the naturally ventilated wall with the significant difference that the ventilation is forced. This means that the system works in situations with high ambient temperatures, as it does not depend on the stack effect alone. The system is thus ideal for hot climates with high cooling loads. During cold periods with no solar irradiation (e.g. during night-time) the ventilation can be minimized for increased thermal insulation. Apart from the advantages in terms of solar and thermal performance the system allows the use of operable windows for natural ventilation, even in highrise buildings”.*

The BBRI, (2002) suggests a more detailed way to classify the active facades according to the:

- Type of ventilation
  - ✧ Natural
  - ✧ Mechanical
- Origin of the airflow
  - ✧ From inside
  - ✧ From outside
- Destination of the airflow
  - ✧ Towards inside
  - ✧ Towards outside
- Airflow direction
  - ✧ To the top
  - ✧ To the bottom (only in case of mechanical ventilation)
- Width of the air cavity
  - ✧ Narrow (10 - 20 cm)
  - ✧ Wide (0.5 - 1m)
- Partitioning
  - ✧ Horizontal (at the level of each storey)
  - ✧ No horizontal partitioning

In this way, 48 different cases can be considered. Even more cases could be created if the different categories would be refined (for instance cavity width). Although this way of categorizing can be very precise, the increased number of categories can be confusing.

## Technical Description

Faist, (1998) compared an airtight façade and a Double Skin Façade that provides natural room ventilation. After this comparison, he concluded the following:

- In an air tight façade:
  - the depth of the façade is not really critical for the temperatures inside the cavity
  - the windows are usually closed; opening the window does not guarantee good room ventilation
  - the canal is open at the bottom and may be closed (by a valve) at the top
  - the double-skin has virtually no noise-insulating effect (comparing to a convectational wall)
  - owing to the air temperature rise in the canal (with solar radiation), the canal height is limited to 3 to 4 levels
- In a ventilated façade:
  - the depth of the façade has to be determined precisely
  - ventilation of the rooms is obtained by opening appropriate valves (sized floor by floor)
  - the canal closed at its base, extends above the last floor level.
  - Noise insulation can be improved when the double-skin screen is installed as the outer layer
  - the allowed height depends on the canal sizing. An upper limit is nevertheless given by the allowed air temperature rise in the canal (10 to 15 storeys)

Oesterle et al., (2001) presents an extensive description of the function and the air flow of the cavity in relation with constructional parameters. The authors mention that only when the cavity between the façade skins is relatively shallow (less than 40 cm) significant pressure losses are likely to occur. Otherwise, the intermediate space offers no major resistance to the air flow.

### 3.2.2 Interior façade openings

Oesterle et al., (2001) mention that the effectiveness of the inner façade in terms of its ventilating function will depend on the opening movement of the windows. The authors make a comparison between various casement opening types in the inner façade skin and their relative ventilating effectiveness in relation to the elevational area of the opening light. The following cases of inner openings are described:

## Technical Description

Uttu, (2001) describes the support structure materials used for the mentioned facades. According to her *“Designers should take care when choosing materials to be used together with glass. This is not simply because of possible incompatibilities in natural properties of the base material, such as coefficient of thermal expansion. It is also because the coatings used with materials may be incompatible or may need maintenance that is difficult to carry out without harming the glass or its coatings in some way”*.

### 3.3.2 Selection of Glass

In most of the literature, one can read that the most common pane types used for Double Skin Facades are:

- For the internal skin (façade): Usually, it consists of a thermal insulating double or triple pane. The panes are usually toughened or unhardened float glass. The gaps between the panes are filled with air, argon or krypton.
- For the external skin (façade): Usually it is a toughened (tempered) single pane. Sometimes it can be a laminated glass instead.

Lee et al., (2002) claim that the most common exterior layer is a heat-strengthened safety glass or laminated safety glass. The second interior façade layer consists of fixed or operable, double or single-pane, casement or hopper windows. Low-emittance coatings on the interior glass façade reduce radiative heat gains to the interior.

Oesterle et al., (2001) suggest that for higher degree of transparency, flint glass can be used as the exterior layer. Since the number of the layers and the thickness of the panes are greater than in single skin construction, it is really important to maintain a “clear” façade. The main disadvantage in this case is the higher construction costs since the flint glass is more expensive than the normal one.

If specific safety reasons occur (i.e. bending of the glass or regulations requiring protection against falling glass), then the toughened, partially toughened or laminated safety glass can be used.

Similar description of the panes used can be found in the existing literature. However, there is no literature connecting the pane types and the shading devices with the construction type (i.e. box window, corridor façade, etc) and the use of the Double Skin Façade (origin and destination of the air flow, etc).

## Double Skin Façades

Poirazis and Rosenfeld, (2003) compared 4 different Double Skin Façade cases where different panes were applied in order to calculate the airflow, the temperatures in different heights of the cavity and other properties. The pane types used are shown below:

Table 3.2 Description of panes applied for different types of Double Skin Façades

Case	1	2	3	4
Outer Pane	8 mm clear float glass	8 mm clear float glass	8 mm clear float glass	6 mm solar control glass
Intermediate Pane	4 mm clear float glass	4 mm clear float glass	6 mm solar control glass	4 mm clear float glass
Inner Pane	4 mm clear float glass	4 mm low-e glass	4 mm clear float glass	4 mm low-e glass

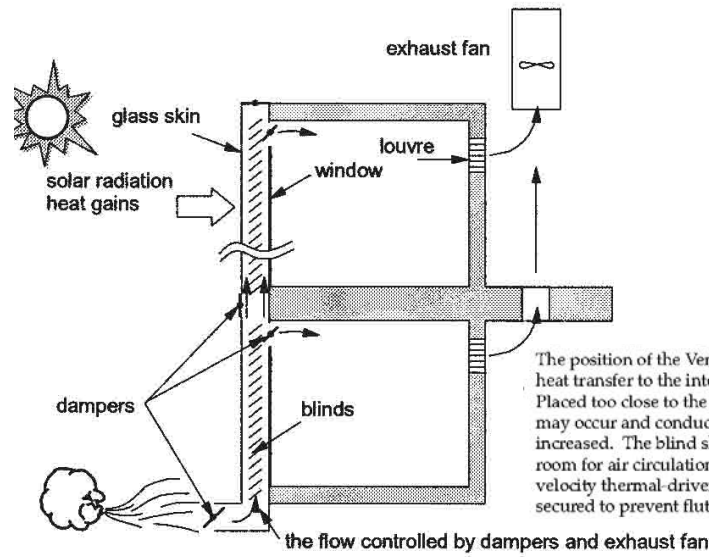
As the authors concluded, the case 1 gives the highest U-Values. The 3<sup>rd</sup> gives slightly lower U-Values. The case 2 and 4 have approximately the same U-Values, lower than the cases mentioned above. The average increase of the mentioned value compared with the cases 2 and 4 is approximately 39.6% for the 1<sup>st</sup> and 34,3% for the 3<sup>rd</sup> case correspondently. Concerning the heat losses, ( $Q_{loss}$ ) the 1<sup>st</sup> and 3<sup>rd</sup> case lead to higher losses than the 2<sup>nd</sup> and the 4<sup>th</sup>.

### 3.3.3 Selection of shading device

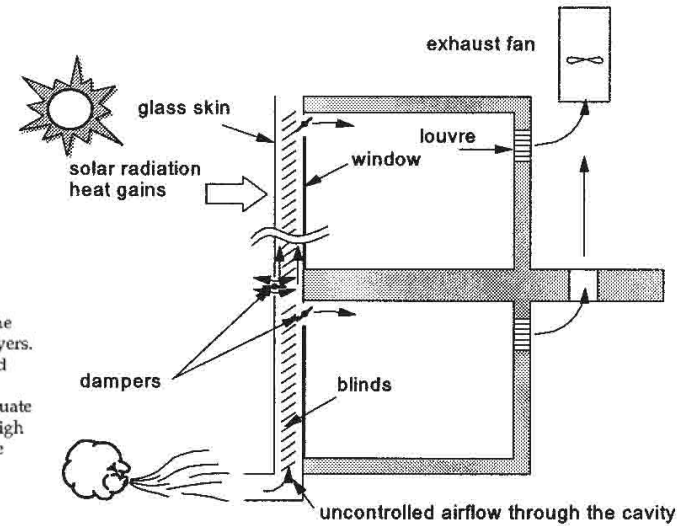
According to Oesterle et al., (2001) *“Determining the effective characteristics of the sunshading in each case poses a special problem at the planning stage since the properties can vary considerably, according to the type of glazing and the ventilation of the sunshading system. The sunshading provides either a complete screening of the area behind it or, in the case of the louvers it may be in a so-called “cut-off” position”*.

As the authors conclude *“for large-scale projects it is worth investigating the precise characteristics of the combination of glass and sunshading, as well as the proposed ventilation of the intermediate space in relation to the angle of the louvers”*.

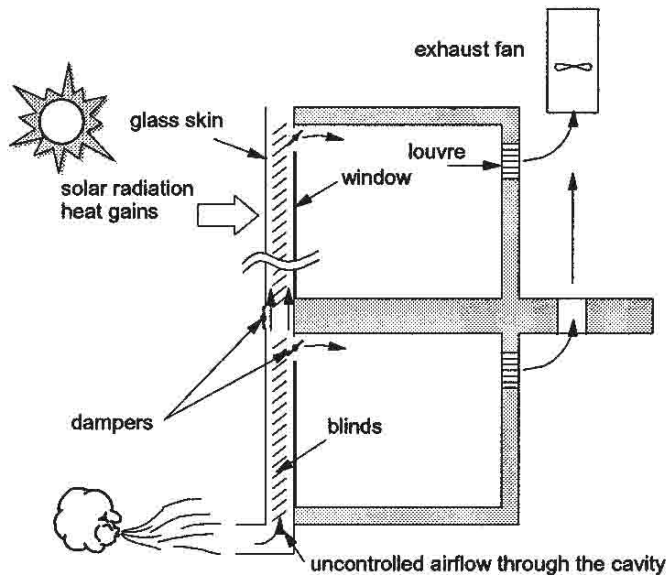
# TYPES OF DOUBLE SKIN / VENTILATION



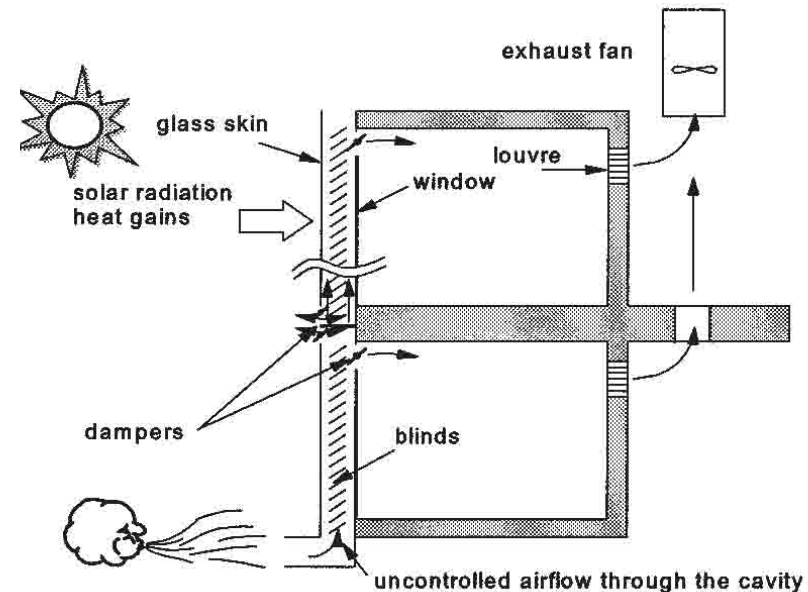
*Controlled air flow in the cavity (Stec et al, 2000)*



*Open junctions in each floor (Stec et al, 2000).*



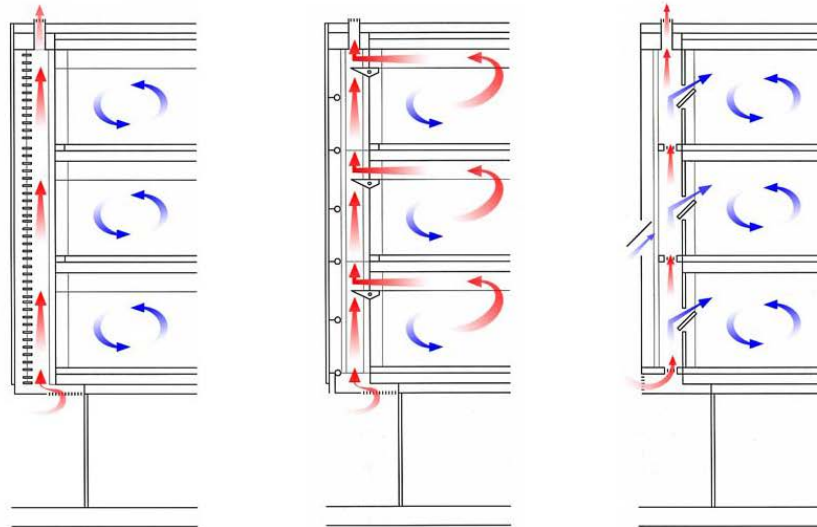
*Uncontrolled air flow in the cavity (Stec et al, 2000).*



*Each storey is separated (Stec et al, 2000).*

temperature extremes, winds, and sound. Sun-shading devices are often located between the two skins. All elements can be arranged differently into numbers of permutations and combinations of both solid and diaphanous membranes.[7]

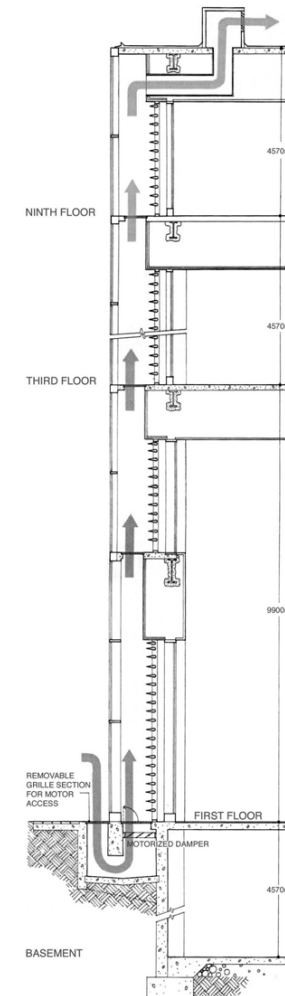
As there are numerous variations in the construction types for double skin facades, it is necessary to create a classification system in order to assess and compare the merits of the various systems as well as the “environmental success” of one building’s skin versus another. In North American based typology three types of general systems are recognized. [8] These refer to the method of classification contained in the Architectural Record Continuing Education article titled, “Using Multiple Glass Skins to Clad Buildings”, by Werner Lang and Thomas Herzog. Lang and Herzog cite three basic system types: Buffer System, Extract Air System and Twin Face System. The three systems vary significantly with respect to ventilation method and their ability to reduce overall energy consumption.



**Figure 1:**  
**Buffer System**

**Figure 2:**  
**Extract-Air System**

**Figure 3:**  
**Twin-Face System**



**Figure 4:**

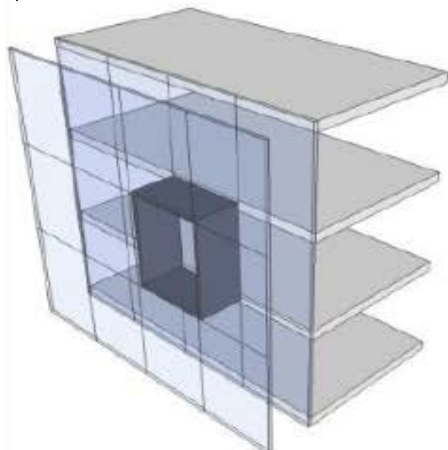
Wall section of the Hooker Chemical Building illustrating a classic buffer façade application that does not allow for fresh air nor mixes the cavity air with the mechanical system.

**Extract Air System:**

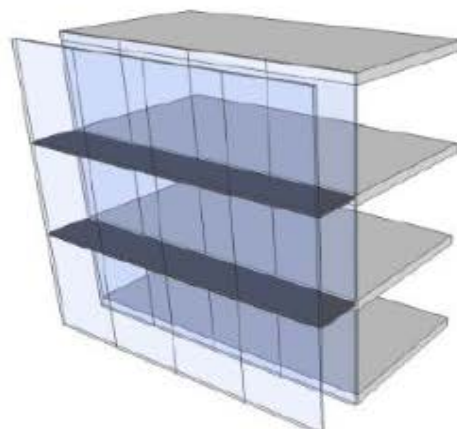
These are comprised of a second single layer of glazing placed on the interior of a main façade of double-glazing (thermopane units). The air space between the two layers of glazing becomes part of the HVAC system. The heated “used” air between the glazing layers is extracted through the cavity with the use of

**Buffer System:**

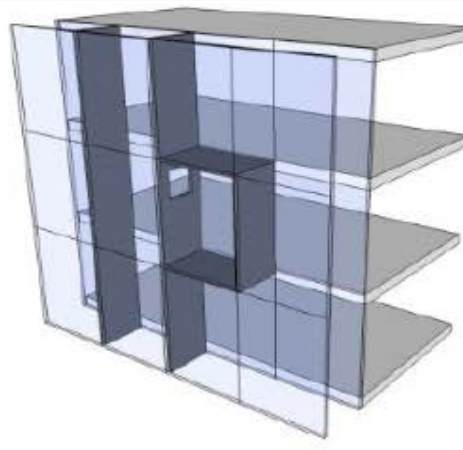
These façades date back some 100 years and are still used. They predate insulating glass and were invented to maintain daylight into buildings while increasing insulating and sound properties of the wall system. They use two layers of single glazing spaced 250 to 900 mm apart, sealed and allowing fresh air into the building through additional controlled means – either a separate HVAC system or box type windows which cut through the overall double skin. Shading devices can be included in the cavity. A modern example of this type is the Occidental Chemical/Hooker Building in Niagara Falls, New York. This building allows fresh air intake at the base of the cavity and exhausts air at the top.



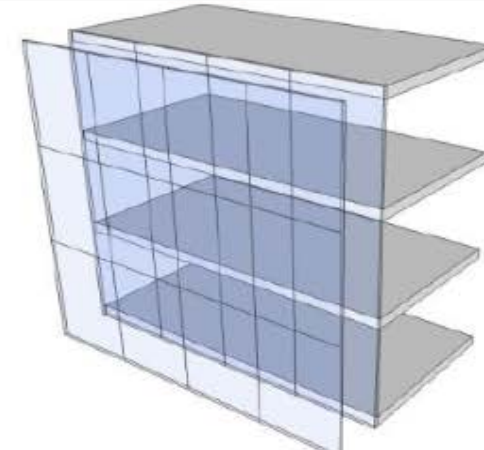
**BOX FAÇADE**



**CORRIDOR FAÇADE**



**SHAFT-BOX FAÇADE**



**MULTI-STOREY FAÇADE**

	Box window type	Shaft box façade	Corridor façade	Multi-storey façade
Sound insulation	Used both when there are high external noise levels or when special requirements concerning sound insulation between adjoining rooms exist	The fewer openings (compared with the box window type) provide better insulation against the external noise	Problems with sound transmission from room to room	Suitable when external noise levels are high, but problems of sound transmission within the intermediate space
Fire protection	Low risk factor (not any room is linked to each other)	Low risk factor (the rooms are only connected with the ventilation shaft)	Medium risk factor (the rooms of the same storey are linked)	High risk factor (all the rooms are linked with each other)
Natural ventilation –air quality	Openable windows, proper for natural ventilation	Caution should be paid in the way that the airstreams are grouped together from a number of façade cavities into a single shaft	Caution should be paid so that the exhaust air from one room doesn't enter the room above. The problem can be solved with the diagonal configuration	As a rule, the rooms behind multi-storey façades have to be mechanically ventilated

*The Undivided Air Space:*

The undivided façade benefits from the stack effect. On warm days hot air collects at the top of the air space. Openings at the top of the cavity siphon out warm air and cooler replacement air is drawn in from the outside. However, without openings at the top of the cavity, offices on the top floors can suffer from overheating due to the accumulation of hot air in the cavity adjacent to their space. The undivided air space can be transformed into atria, allowing people to occupy this "environmentally variable interstitial space".[9] The atria/air cavity can be used programmatically for spaces with low occupancy (meeting rooms or cafeterias). Plants are used in these spaces to filter and moisten the air as well as act as shading devices.

*The Divided Air Space:*

The divided air space can reduce over-heating on upper floors as well as noise, fire and smoke transmission. Floor-by-floor divisions add construction simplicity of a repeating unit and in turn can produce economic savings. Corridor façades (commonly used in twin-face façades) have fresh air and exhaust intakes on every floor allowing for maximum natural ventilation. Shaft façades (divided into vertical bays across the wall), draw air across the façade through openings allowing better natural ventilation. However, the shaft façade becomes problematic for fire-protection, sound transmission and the mixing of fresh and foul air.[10]

*Cleaning the Air Space:*

The design of the air space also impacts cleaning. The continuous cavity, as can be seen in both the Hooker and Telus buildings, uses either a bosun's chair or platform, similar to a window-washing rig, to access the interior of the space for cleaning. Any louvers that are located within the cavity must be able to be moved to facilitate access. In some air spaces designers put open grates at each floor level. These still permit airflow through the space but provide a platform upon which to stand when cleaning the cavity floor by floor. In some instances, where the cavity is more divided, the interior windows, whether operable for ventilation or not, will function as access panels for cleaning crews to enter the space for maintenance. Where there has to be occupation of the air space for cleaning, the interior clear dimension is usually in the 600 to 900 mm range. Where the dimensions are small, cleaning is done from within the office space and requires that interior window panels open fully to provide adequate access for cleaning.

If the aesthetic drive behind the use of the fully glazed double façade is key, maintenance is critical. Research would indicate that full cleaning is carried out anywhere from 2 to 4 times a year and is a function of the cleanliness of the air that is passing through the space. Where the early design of the Hooker building (1983) provided a continuous cavity and fully open grilles at the base for continuous intake air, the Telus Building (2001), includes timed dampers to close off the air intakes at the base during times of peak traffic.



# DOUBLE SKIN FAÇADE - QUESTIONS

FAÇADE LAYERS		Comments
<b>Class layers</b>		
- Optical properties	Spectral? Angular dependent? Optical properties different for direct, diffuse and reflected (incident) solar radiation?	
- Thermal properties	Function of the temperature?	
<b>Shading device</b>		
- Type of shading device	Modelling of any type of shading device? (roller blind, Venetian blind with orientable slats, etc.) Overhang?	
- Optical properties	Spectral? Angular dependent?	
- Position of shading device in the cavity	Attached to the internal or external glass skins? Placed in center of the cavity?	
- Control	Can the shading device be controlled?	Pull down or roll up the blind according to the sunshine level, temperature, etc.
<b>Frame</b>		
- Modelling	Possible?	
- Thermal properties	Can ventilation air pass through the frame? Thermal properties function of the airflow rate passing through the frame?  Possibility to set an inlet temperature (air entering the ventilated cavity) different to the exterior or interior temperature?	For certain applications, it is important that the frame of the ventilated double facade can be modelled. The heat transmission through the frame can represent a non-negligible part of the total heat transmission losses through the complete façade. Air entering the ventilated cavity can be heated and cooled down due to contact with the bounding surfaces and heating due to solar radiation. The inlet temperature in the cavity influences both the transmission losses and the enthalpy change of the air flowing through the cavity.
<b>Cavity subdivision</b>		
- Vertical	Vertical subdivision?	The number of zones into which the façade must be divided is not straightforward. This vertical subdivision is needed to take into account the temperature profile in the cavity.
- Horizontal	Horizontal subdivision?	Fictive vertical walls can be simulated? (in some programs it is needed to model fictive vertical walls to represent the shading device rolled up)

HEAT TRANSFER		
<b>Convective heat transfer in the cavity</b>		
- Forced convection	Convective heat transfer coefficient: - must it be given (fixed value?) Possibility to modify the value of the coefficient during the simulation (in function of some inputs)? - is calculated from some parameters? (flow regime, airflow rate, temperature difference, etc.)	
- Natural convection	Possibility to model natural ventilation in the cavity? (naturally ventilated facades)	See also "Air flow modelling" (see below)
<b>Radiative heat transfer</b>		
- In the cavity	Radiation and convection treated separately? Radiation heat transfer coefficient is a function of the temperature?	
- Exterior radiation heat transfer	Calculated from sky temperature and environment temperature?	
- View factor	Correct determination of the view factor between facing panes?	
<b>Short wave radiation</b>		
- All panes	Inter-reflections between the glass panes and the shading device?	
- Venetian blind	Inter-reflections between the slats of the Venetian blind?	
<b>AIR FLOW MODELLING</b>		
- Coupling air flow modelling and thermal modelling	- Combination of a thermal and an airflow network in the same software? - Possibility to combine the software to airflow models? (other software)	
- Natural ventilation	Buoyancy effect? (stack effect) Wind effect? Airflow between the cavity and the interior of the building through the window openings?	
- Coupling façade and building	Possibility to connect the façade model with the building and its installations	



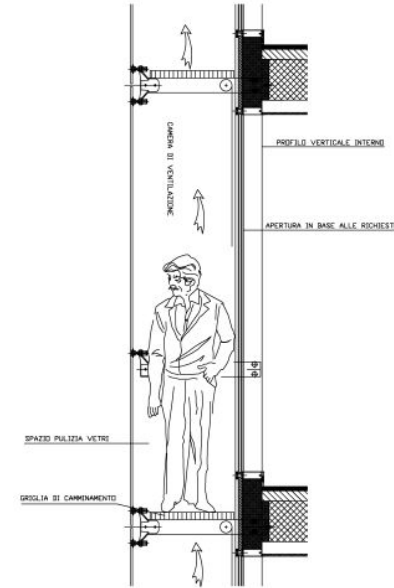


UNIVERSITÀ  
DEGLI STUDI  
FIRENZE  
Scuola di  
Architettura



INTERNATIONAL COURSE ON  
ARCHITECTURAL DESIGN

# DOUBLE SKIN: CORRIDOR FAÇADE





UNIVERSITÀ  
DEGLI STUDI  
FIRENZE  
Scuola di  
Architettura

**iCAD**

INTERNATIONAL COURSE ON  
ARCHITECTURAL DESIGN

## DOUBLE SKIN – BOX FAÇADE





## Eurotheum

Location: Frankfurt, Germany  
System: Double-skin façade  
Architect: Novotny Mähner + Associates  
Completion: 1999

**Project Description:** This residential and office mixed-use building is 100-m high and has a square 28 by 28 m plan. Only part of the building is designed with a double-skin façade, which provides natural ventilation for most of the year. Office space occupies the lower part of the Eurotheum Tower while the top seven floors are used for residential purposes.

The façade grid is 1350 mm wide and 3350 mm tall. Each unit, which is pre-fabricated off-site, consists of a 6-grid span, one-storey tall. The internal skin consists of thermally-broken aluminum frames and double-pane, manually-operated, tilt-and-turn windows. Power-operated blinds are located in the 34-cm-wide air cavity corridor. The external skin consists of single-pane, fixed glazing. Fresh air is supplied through 75-mm diameter holes in the vertical metal fins on each side of the glazing unit. Warm air is extracted through an exterior opening at the ceiling level. This opening is equipped with louvers to prevent the penetration of rain and is covered with anti-bird mesh.

## Reference

Hertzsch, E. 1998. Double Skin Façades. Catalog of Josef Gartner & Co. Munich: Peschke.

[http://www.hlzm.de/pdf/226Euroth\\_eng.pdf](http://www.hlzm.de/pdf/226Euroth_eng.pdf) (no information on double-skin façade)



Exterior view w



Another example of a building constructed several years ago was designed by Christoph Ingenhoven in Essen. It is an example of the earlier types of these buildings and it prompted a lot of international attention focused on these double-wall systems. When you see this building in reality, it is extraordinarily small and has a very complex double wall system done by Gartner. This building serves as a touch point for many people in terms of double wall construction; an example of what might be done and how incredibly excessive this undertaking was. This is a building represents an extraordinary investment made on the exterior of the building for daylighting and energy conservation purposes; simultaneously this building, with a very, very small floor plate, has a fully-functioning mechanical system in it that would allow it to be operated with any type of curtain wall on it, including a conventional monolithic glass wall. It is a building that has a redundancy of systems and an extraordinarily small amount of floor area. It is an example of wonderful work spaces and provides this small town with an extraordinary urban identity, which is quite significant. That, of course, is one of the roles that these buildings have always played – that they serve as either a corporate or municipal role, communicating a unique, highly tuned agenda or identification for that company or that particular municipality.

67



Essen, Christoph  
Ingenhoven.

observer and office occupant, the wall section at the CDP does not greatly differ from a traditional façade system that incorporated both fixed and operable glazing panels.

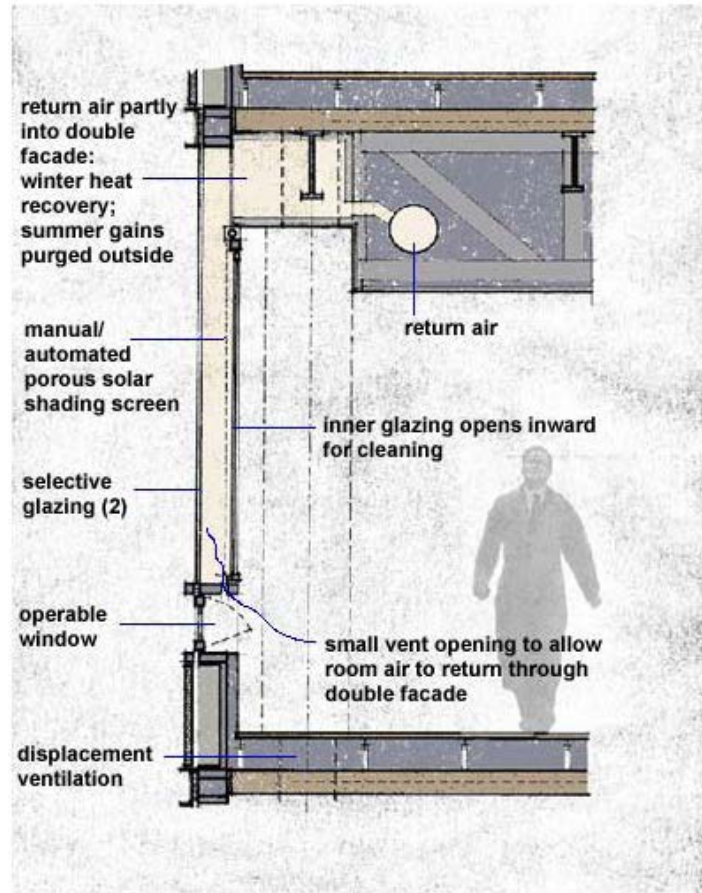


Figure 7:  
Wall section detail of the CDP



Figure 8:  
Interior view of the office space

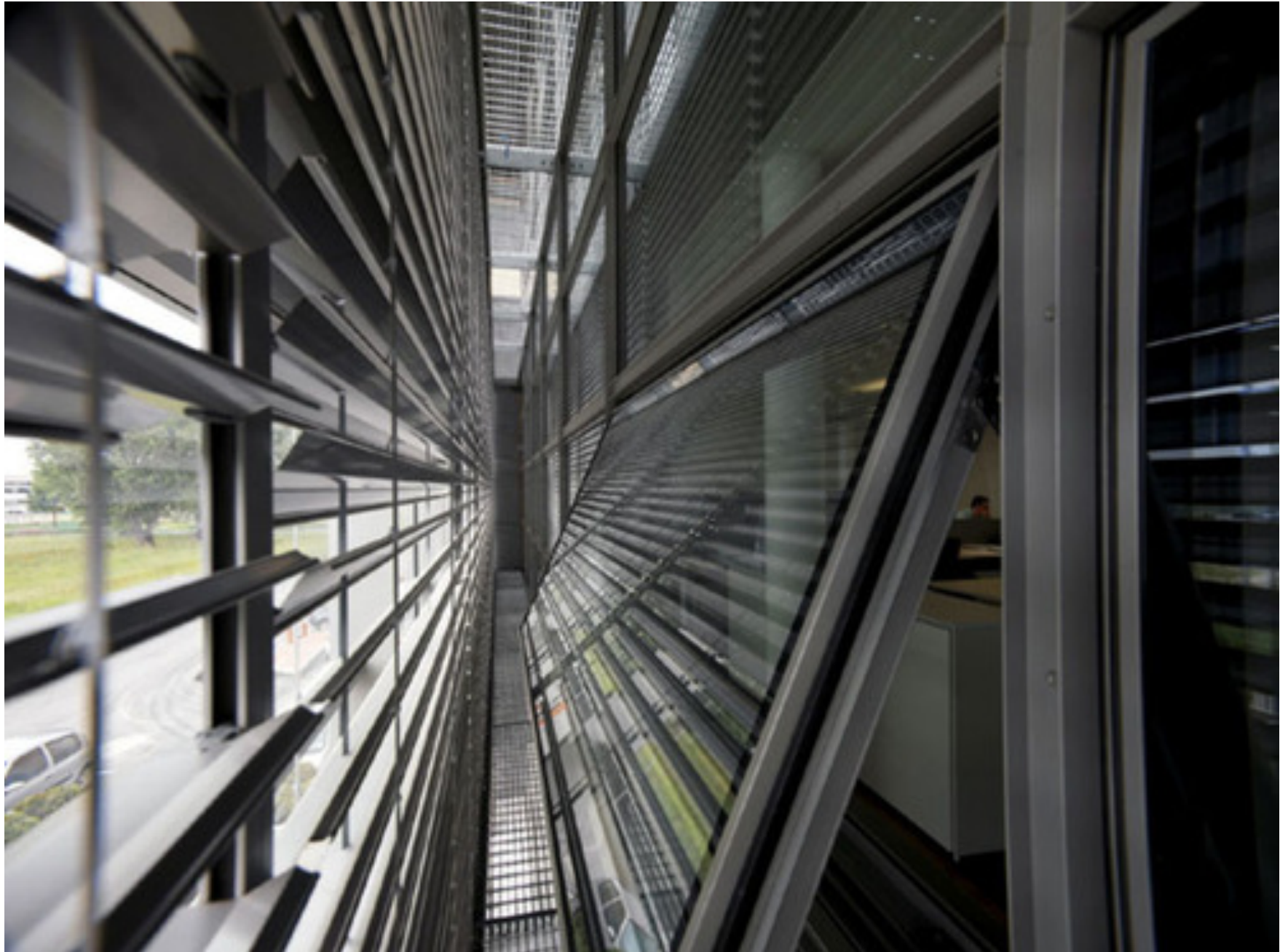


UNIVERSITA'  
DEGLI STUDI  
FIRENZE  
Scuola di  
Architettura

**iCAD**

INTERNATIONAL COURSE ON  
ARCHITECTURAL DESIGN

# EXTERIOR SOLAR CONTROL- MATERIALS





UNIVERSITÀ  
DEGLI STUDI  
FIRENZE  
Scuola di  
Architettura

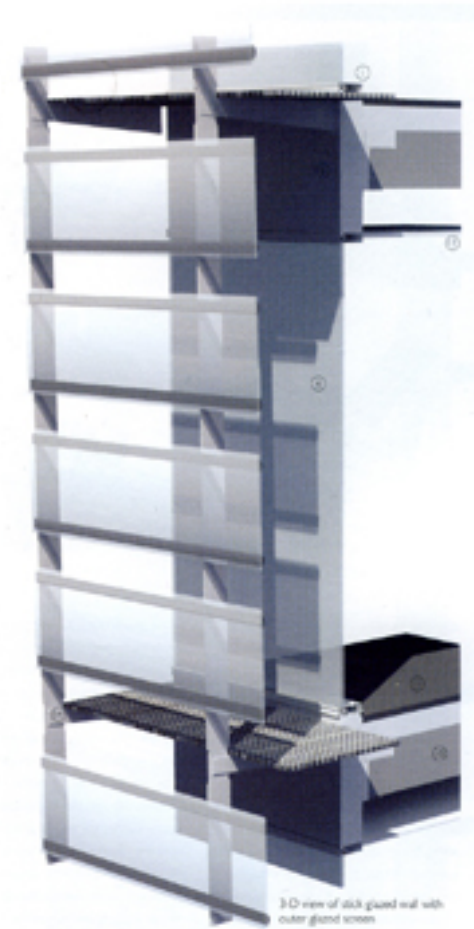
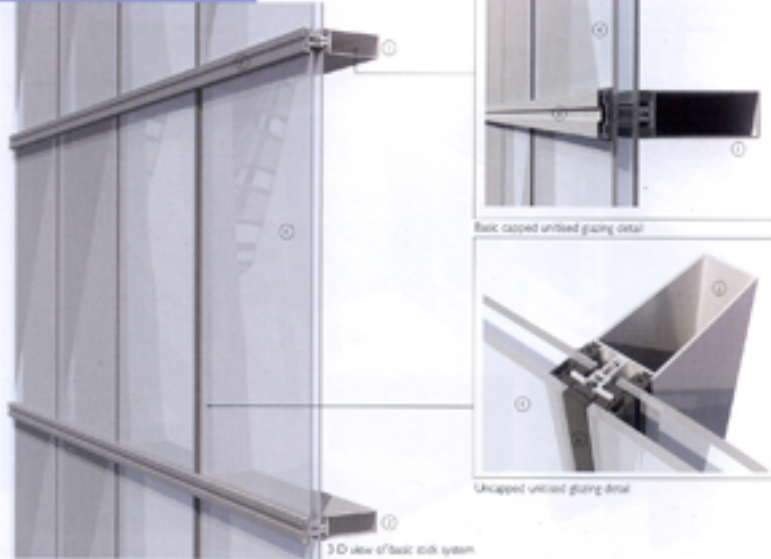
**iCAD**

INTERNATIONAL COURSE ON  
ARCHITECTURAL DESIGN

# EXTERIOR SOLAR CONTROL- MATERIALS



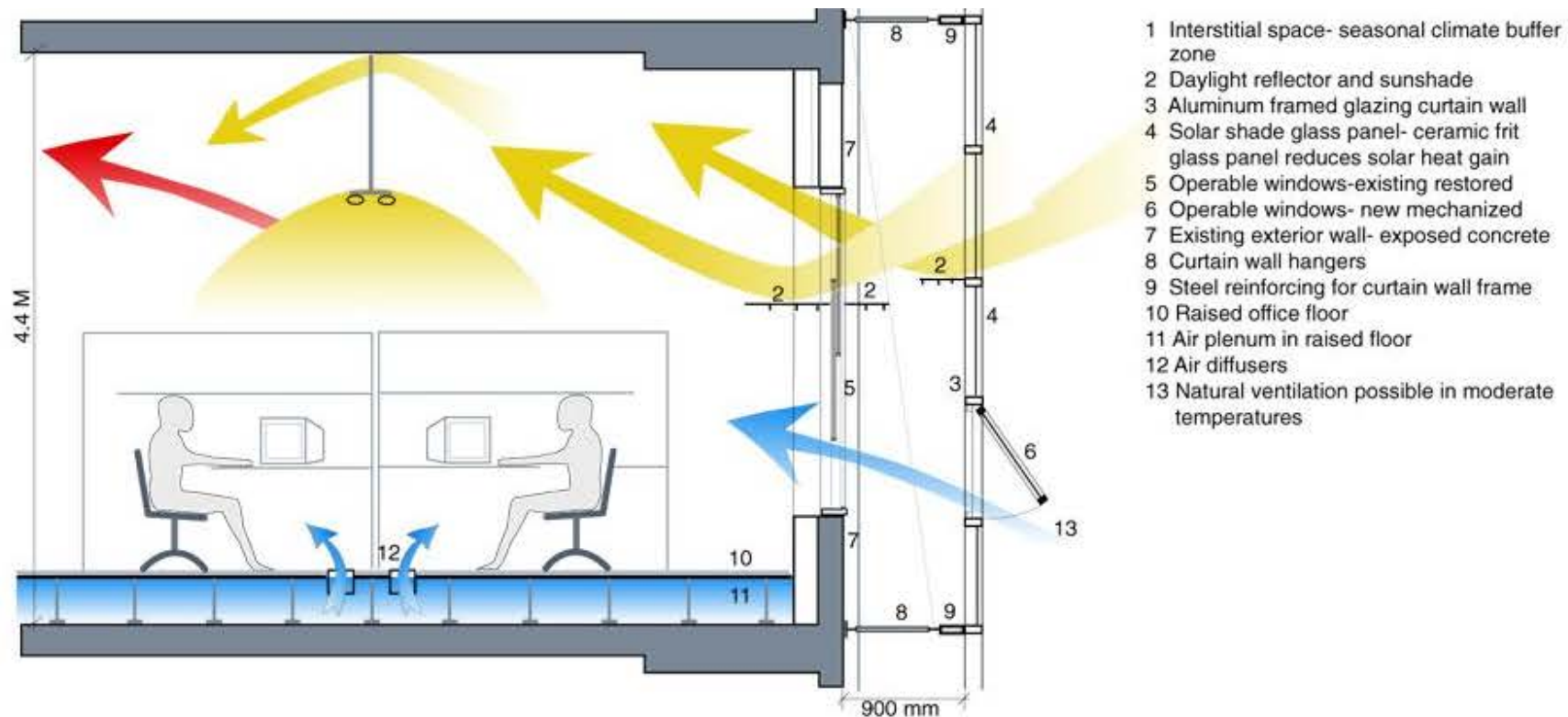
Walls 02  
Glass systems: 1: stick systems



- Details**
1. Extruded aluminium transom
  2. Extruded aluminium mullion
  3. Extruded aluminium section
  4. Single glazed or double glazed unit
  5. Pressure plate
  6. Rubber-based seal
  7. Metal honeycomb panel
  8. Cupping piece
  9. Metal fence or spacer glass/fence insulated panel
  10. Floor slab
  11. Floor finish
  12. Ceiling finish
  13. Thermal break
  14. Projecting bracket to support external screen



# DOUBLE SKIN: CORRIDOR FAÇADE



**Figure 9:**  
The room section at Telus, Vancouver

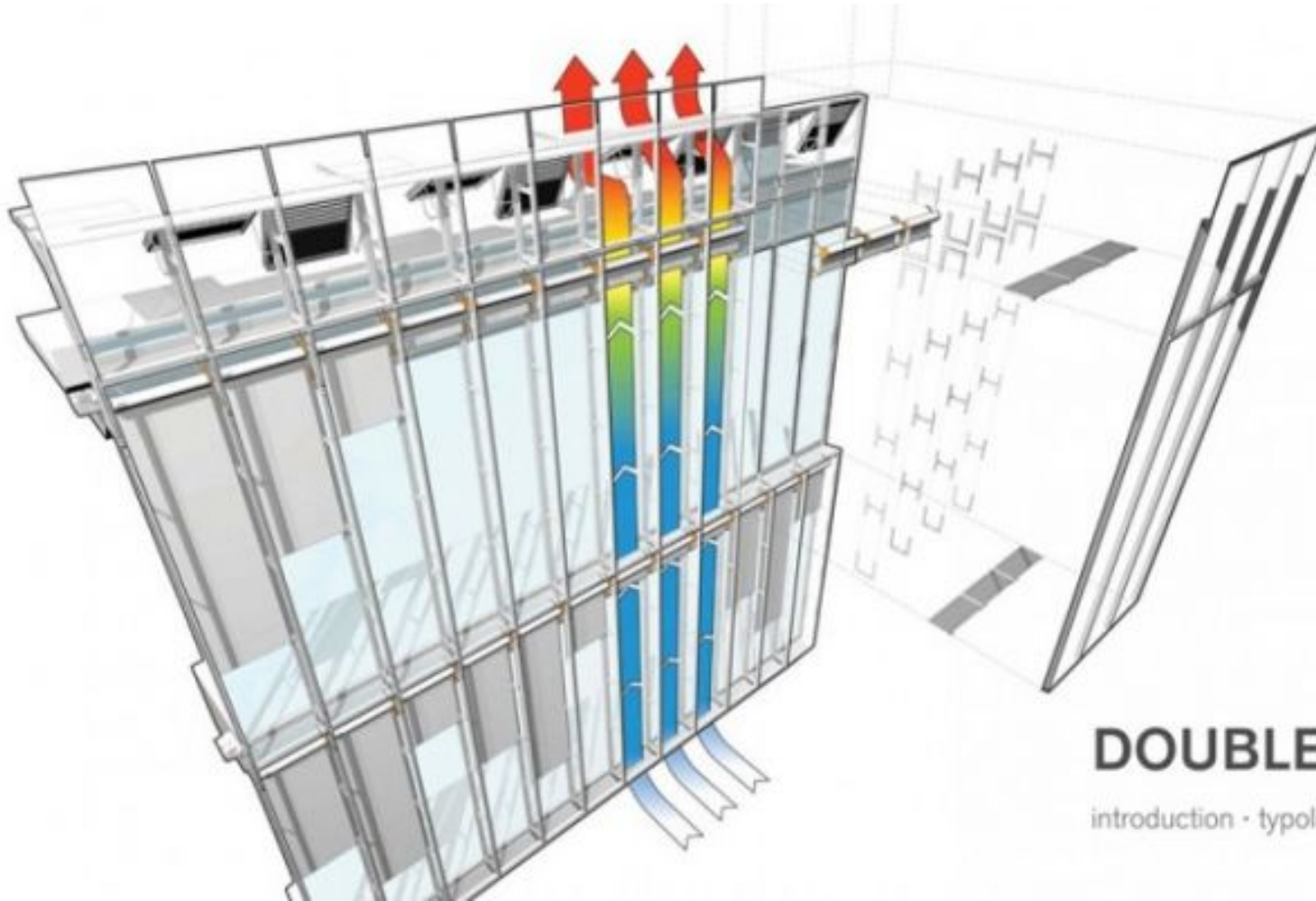


UNIVERSITÀ  
DEGLI STUDI  
FIRENZE  
Scuola di  
Architettura

**iCAD**

INTERNATIONAL COURSE ON  
ARCHITECTURAL DESIGN

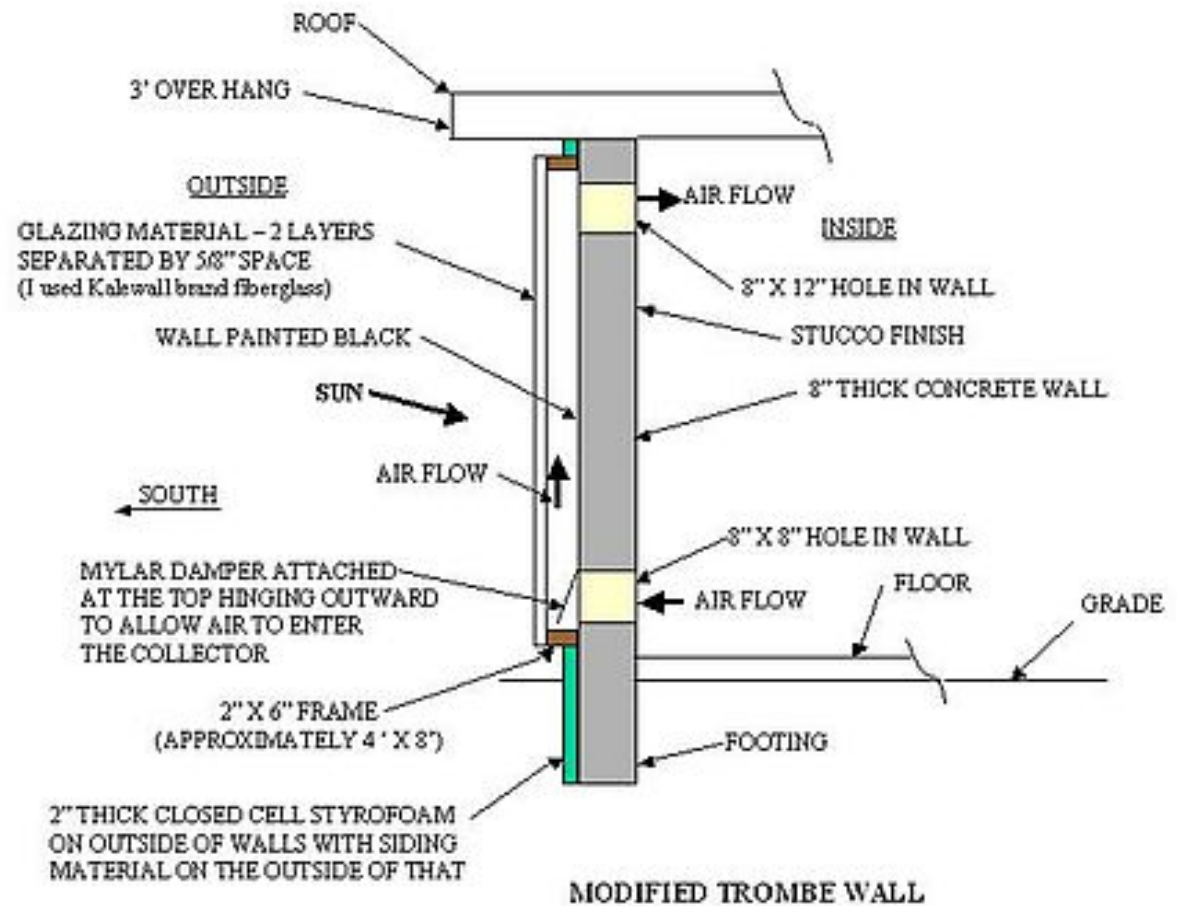
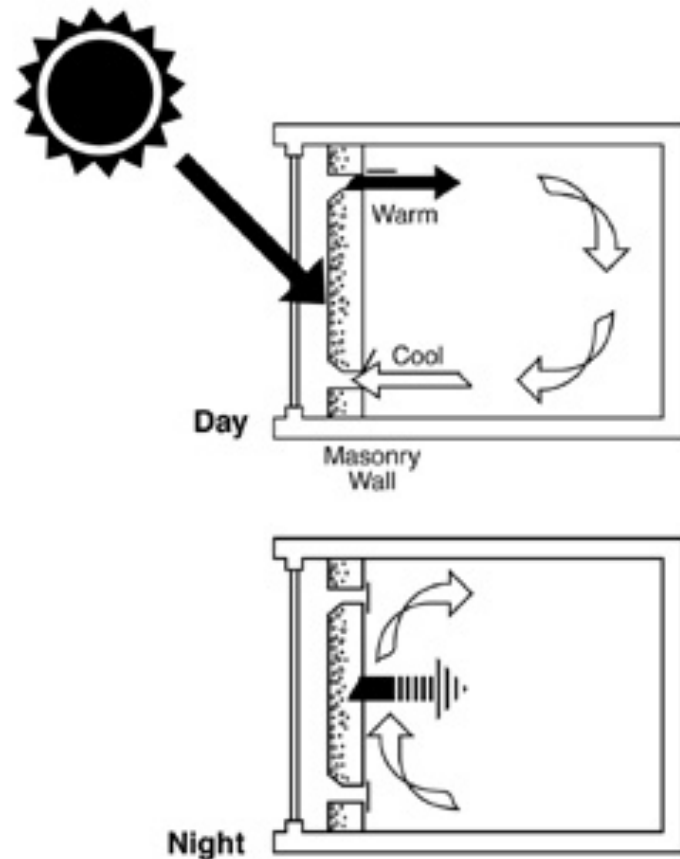
# DOUBLE SKIN: MULTISTOREY FAÇADE



## DOUBLE-SKIN FACADES

introduction • typology • evolution • design • applications

# DOUBLE SKIN FAÇADE-TROMBE WALL



# DOUBLE SKIN FAÇADE-TROMBE WALL

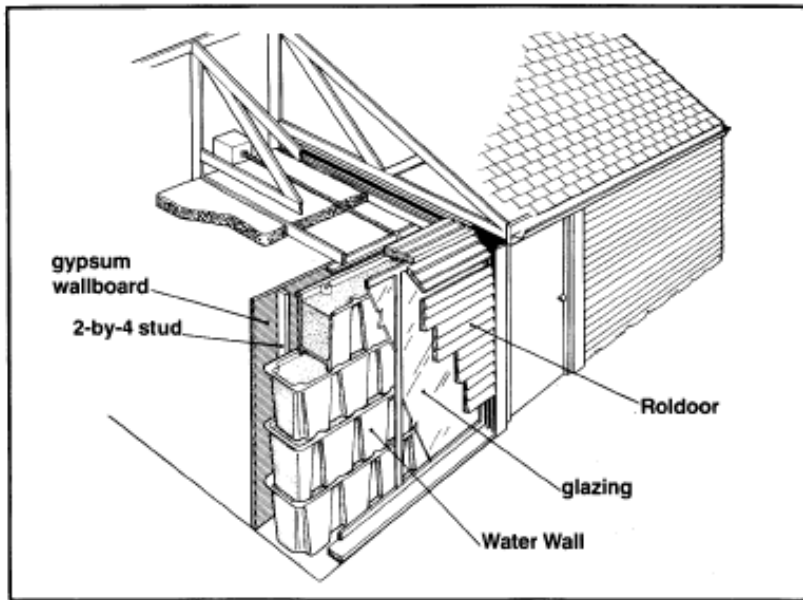
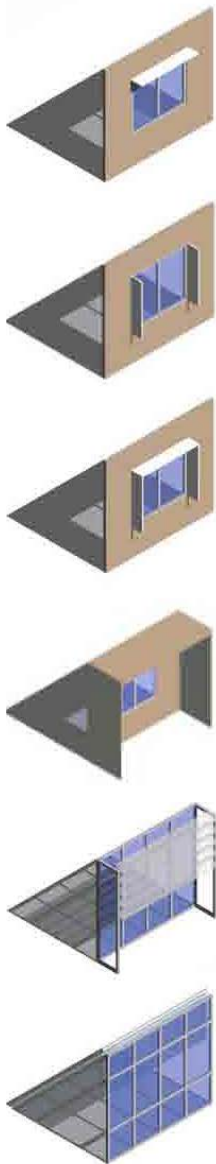


Figure 17-1: The Roldoor system with stacking Water Wall modules.



## Exterior solar control



Exterior solar control can be provided by overhang, fin, or full window screen geometries — the shape and material of which defines the architectural character of the building. The general concept is to intercept direct sun before it enters the building. Once direct sun enters the building, the only way it can get back out is through reflection (only the visible and near-infrared wavelengths of solar radiation can be reflected back out) or indirectly by convection and long-wave radiation. Exterior solar control should be designed to intercept direct sun for the periods of the year when cooling load control is desired (which tends to be 6-8 months out of the year in California for most commercial buildings). Shading systems that cover the entire face of the window (screens, blinds, etc.) should be placed back from the exterior glass surface to allow free air flow. A prevalent type of solar control in Europe is retractable louvers and blinds and is discussed briefly here.

Louvers and blinds are composed of multiple horizontal or vertical slats. Exterior blinds are more durable and usually made of galvanized steel, anodized or painted aluminum or PVC for low maintenance. Appropriate slat size varies and tends to be wider for exterior use. Slats can be either flat or curved. With different shape and reflectivity, louvers and blinds are used not only for solar shading, but also for redirecting daylight.

While fixed systems are designed mainly for solar shading, operable systems can be used to control thermal gain, reduce glare, and redirect sunlight. Operable systems (whether manual or automatically controlled) provide more flexibility because the blinds can be retracted and tilted, responding to the outdoor conditions. Glossy reflective blinds can be used to block direct sunlight while redirecting light to the ceiling at the same time. This might generate glare, depending on the slat angle, if direct sun is reflected off the slat surface into the field of view.

Louvers and blinds perform well in all climates. For commercial buildings in hot climates, the system may be more energy-efficient if placed on the exterior of the building while blocking solar radiation. For buildings in cold climates, the system can be used to provide more daylight and absorb solar radiation.

Sketches of various exterior shading systems (at left, from top to bottom)

Horizontal overhang protects south facades from high-angle sun during the day.

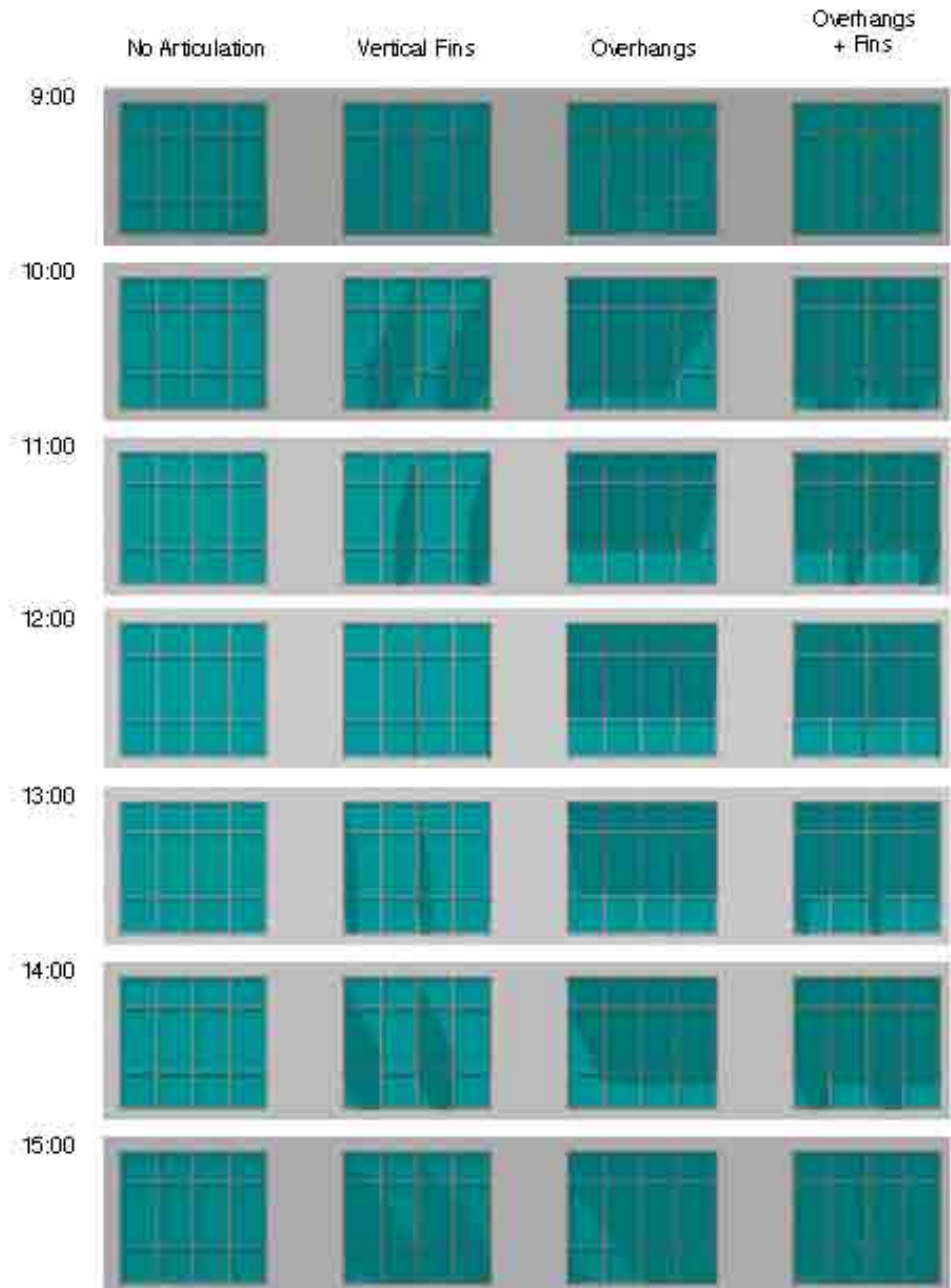
Vertical fins protect window facades from east and west low-angle sun.

Overhang and fins combined can be applied to buildings in hot climates.

Window setbacks, where the window plane is pushed inward from the face of the building, can provide good shading potential.

Fixed or moveable horizontal louvers provide shading similar to an overhang with improved daylight potential.

Interior blinds can be controlled to accommodate occupant preferences.





UNIVERSITÀ  
DEGLI STUDI  
FIRENZE  
Scuola di  
Architettura



INTERNATIONAL COURSE ON  
ARCHITECTURAL DESIGN

# EXTERIOR SOLAR CONTROL- MORFOLOGY





UNIVERSITÀ  
DEGLI STUDI  
FIRENZE  
Scuola di  
Architettura



INTERNATIONAL COURSE ON  
ARCHITECTURAL DESIGN

# EXTERIOR SOLAR CONTROL- MORFOLOGY



libreria i.gardella



UNIVERSITA'  
DEGLI STUDI  
FIRENZE  
Scuola di  
Architettura



INTERNATIONAL COURSE ON  
ARCHITECTURAL DESIGN

## EXTERIOR SOLAR CONTROL- MORFOLOGY



*Gabriele Basilico - Dispensario Antitubercolare, Alessandria, 1933-1937 (Arch. Ignazio Gardella) - 1980-82 - stampa ai sali d'argento su carta baritata cm 23x38 - courtesy coll. Francesco Moschini e Gabriel Vaduva, A.A.M. Architettura Arte Moderna, Roma*





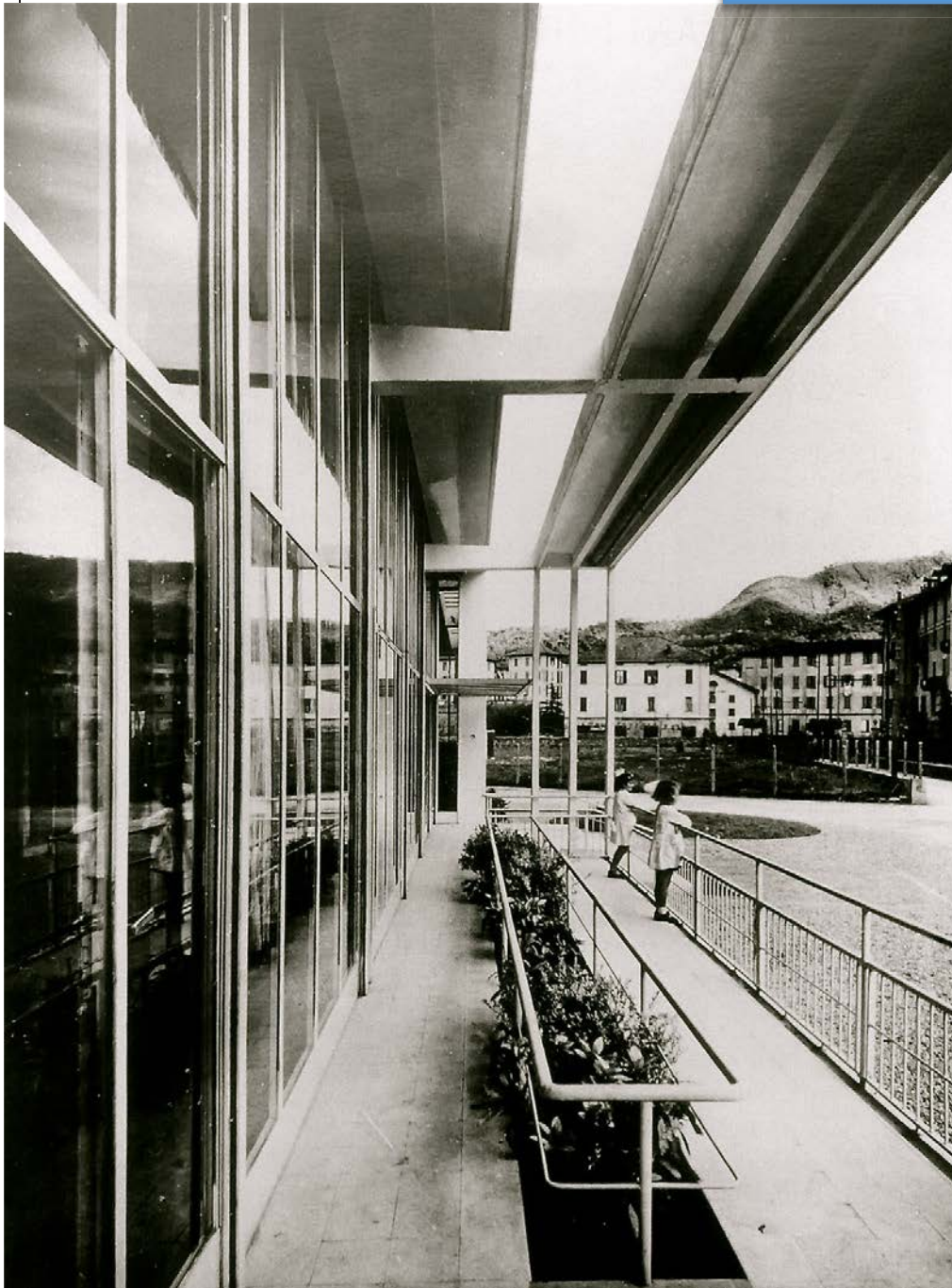
UNIVERSITA'  
DEGLI STUDI  
FIRENZE  
Scuola di  
Architettura



INTERNATIONAL COURSE ON  
ARCHITECTURAL DESIGN

# EXTERIOR SOLAR CONTROL





Giuseppe Terragni, Asilo  
Sant'Elia, Como 1936-1937



UNIVERSITÀ  
DEGLI STUDI  
FIRENZE  
Scuola di  
Architettura



INTERNATIONAL COURSE ON  
ARCHITECTURAL DESIGN

# EXTERIOR SOLAR CONTROL



Le Corbu, Curutchet House, La  
Plata, 1949-55

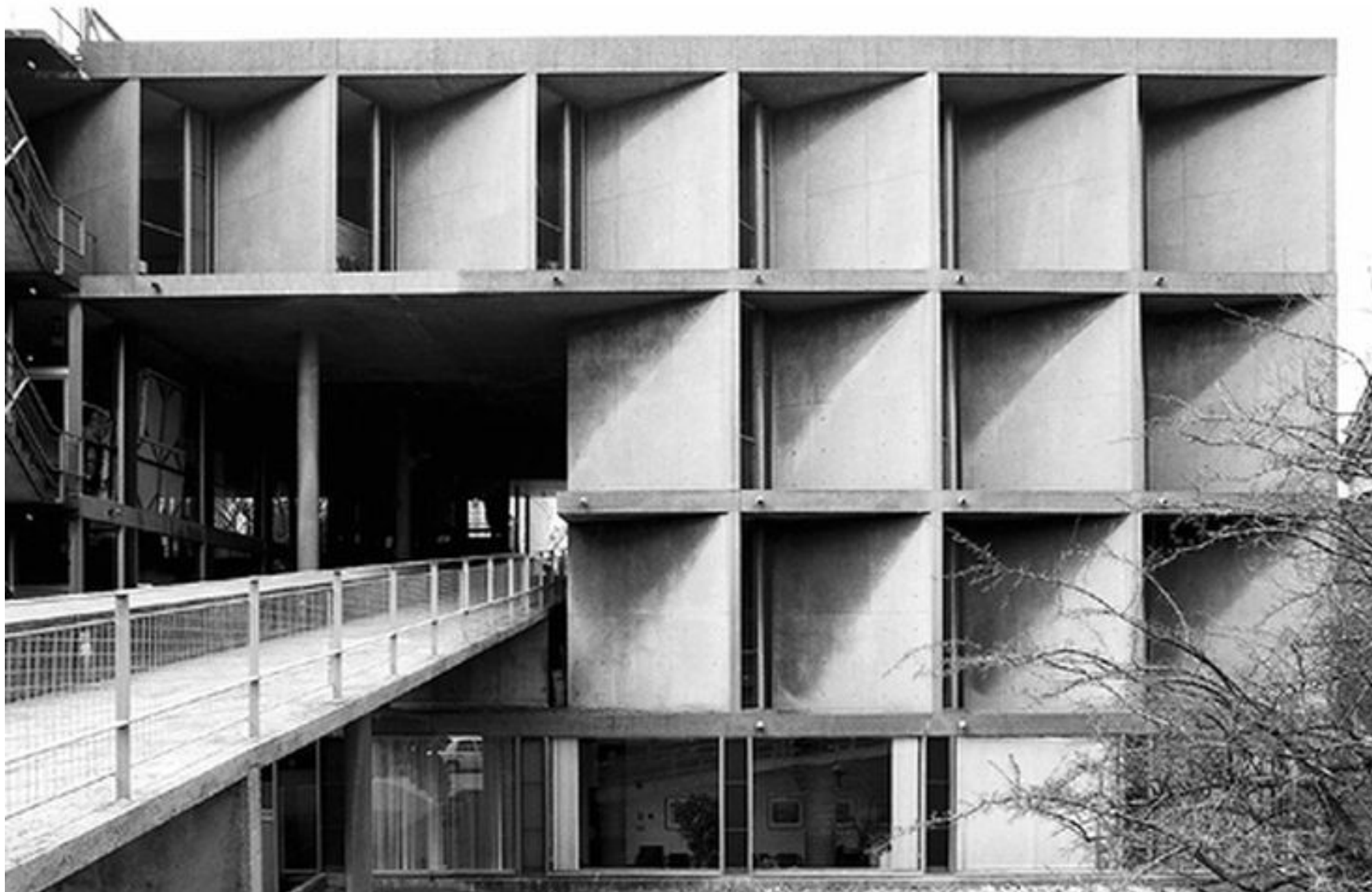


UNIVERSITÀ  
DEGLI STUDI  
FIRENZE  
Scuola di  
Architettura



INTERNATIONAL COURSE ON  
ARCHITECTURAL DESIGN

# EXTERIOR SOLAR CONTROL- MORFOLOGY





UNIVERSITÀ  
DEGLI STUDI  
FIRENZE  
Scuola di  
Architettura



INTERNATIONAL COURSE ON  
ARCHITECTURAL DESIGN

# EXTERIOR SOLAR CONTROL- MORFOLOGY



Chandigarh High Court of Justice - Le Corbusier



UNIVERSITÀ  
DEGLI STUDI  
FIRENZE  
Scuola di  
Architettura

**iCAD**

INTERNATIONAL COURSE ON  
ARCHITECTURAL DESIGN

# EXTERIOR SOLAR CONTROL- MORFOLOGY

The Brise Soleil Milam House Paul Rudolph





UNIVERSITA'  
DEGLI STUDI  
FIRENZE  
Scuola di  
Architettura



INTERNATIONAL COURSE ON  
ARCHITECTURAL DESIGN

# EXTERIOR SOLAR CONTROL- MORFOLOGY





UNIVERSITÀ  
DEGLI STUDI  
FIRENZE  
Scuola di  
Architettura



INTERNATIONAL COURSE ON  
ARCHITECTURAL DESIGN

# EXTERIOR SOLAR CONTROL- MORFOLOGY

Young Museum).

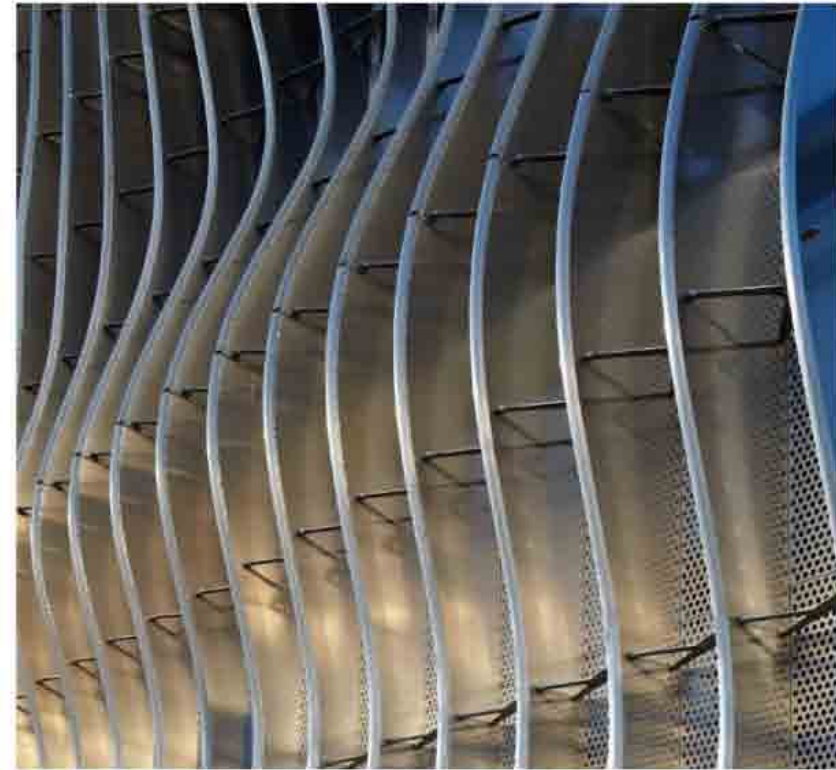
- The third tool is a completely new technology, which enables designers to build standard glass and metal facades, but with a variety of customizable material claddings and will be available Spring/Summer 2014.

"With our tool, everything you design is quantifiably buildable," says Zahner engineer Craig Long, "And quantifiably buildable designs have concrete costs. So we thought, what happens when a designer can see the cost of a facade? It's that missing piece of the puzzle. For the designer, it's knowledge, and it's power."

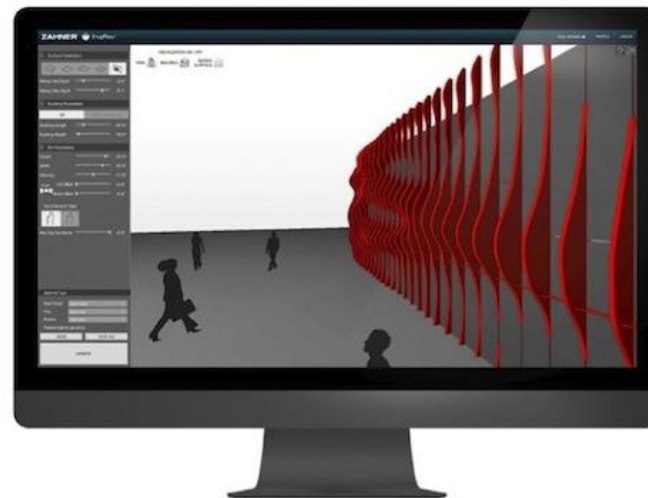
For more information, visit <http://shopfloor.azahner.com>.



Zahner's Headquarters in Kansas City, the first facade system available for ShopFloor. Photo © Mike Sinclair, © A. Zahner Company



Detail of the fin-based facade for Zahner's Headquarters, the first facade system available for ShopFloor. Photo © Mike Sinclair, © A. Zahner Company







UNIVERSITÀ  
DEGLI STUDI  
FIRENZE  
Scuola di  
Architettura

**iCAD**

INTERNATIONAL COURSE ON  
ARCHITECTURAL DESIGN

# EXTERIOR SOLAR CONTROL- MORFOLOGY

Retrofit sail to address  
shading problem in  
Waterloo Train Station,  
London. Architect:  
Nicholas Grimshaw.





UNIVERSITÀ  
DEGLI STUDI  
FIRENZE  
Scuola di  
Architettura

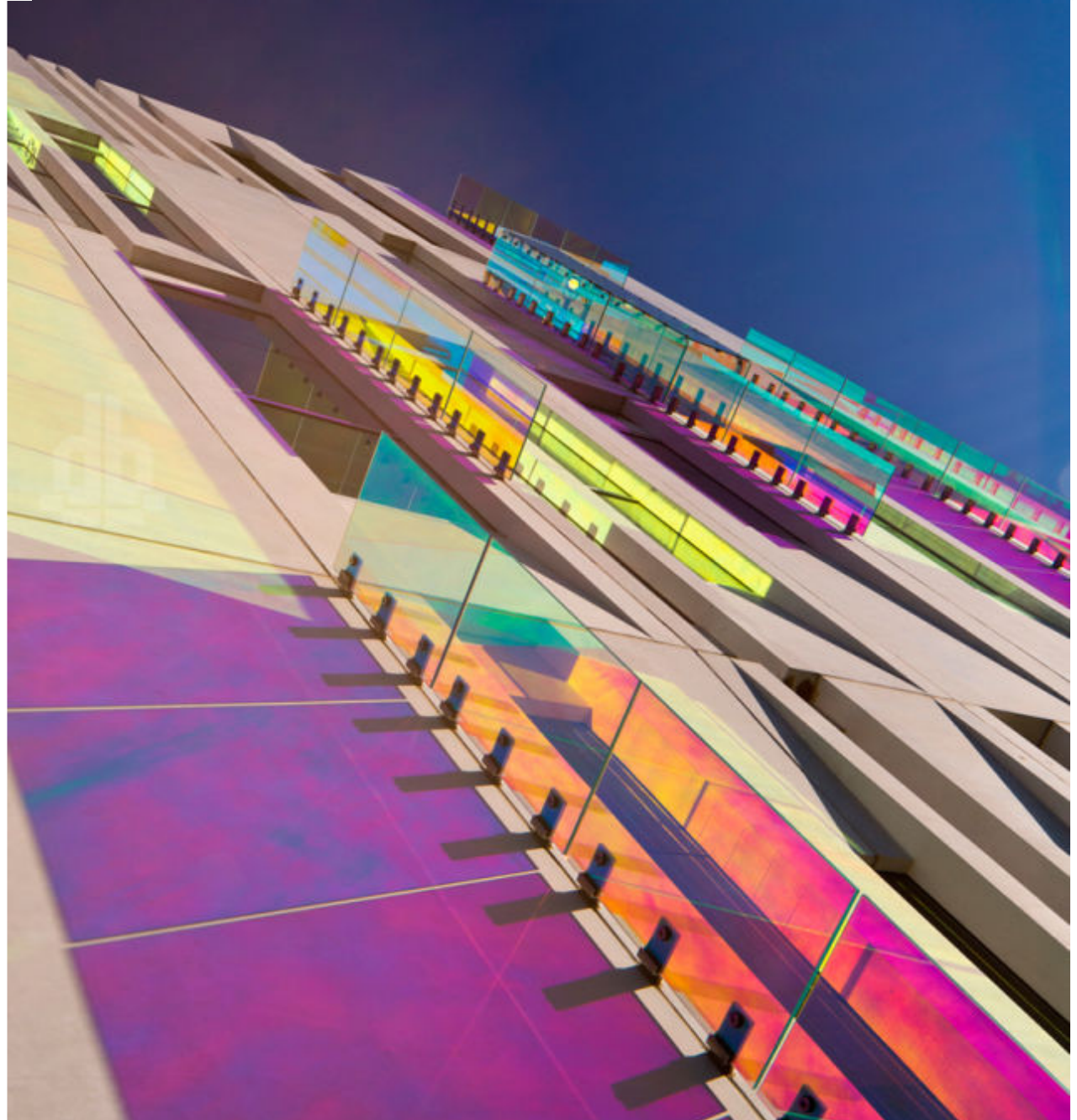


INTERNATIONAL COURSE ON  
ARCHITECTURAL DESIGN

# EXTERIOR SOLAR CONTROL- MORFOLOGY

## University of Ohio's Central Chiller Plant

Fins made from dichroic glass—which refracts light in colors because of embedded layers of metal and oxides—cast rainbows on the cooling equipment inside. The reflections from these fins move as the sun changes, like glittering fish gills, or water reacting to light.





UNIVERSITÀ  
DEGLI STUDI  
FIRENZE  
Scuola di  
Architettura



INTERNATIONAL COURSE ON  
ARCHITECTURAL DESIGN

# EXTERIOR SOLAR CONTROL- MORFOLOGY



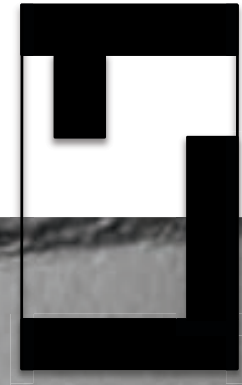


UNIVERSITÀ  
DEGLI STUDI  
FIRENZE  
Scuola di  
Architettura



INTERNATIONAL COURSE ON  
ARCHITECTURAL DESIGN

# EXTERIOR SOLAR CONTROL- MORFOLOGY





UNIVERSITÀ  
DEGLI STUDI  
FIRENZE  
Scuola di  
Architettura

**iCAD**

INTERNATIONAL COURSE ON  
ARCHITECTURAL DESIGN

# EXTERIOR SOLAR CONTROL- MORFOLOGY





UNIVERSITÀ  
DEGLI STUDI  
FIRENZE  
Scuola di  
Architettura



INTERNATIONAL COURSE ON  
ARCHITECTURAL DESIGN

EXTERIOR SOLAR CONTROL- MORFOLOGY

# SALEWA HEADQUARTERS





UNIVERSITÀ  
DEGLI STUDI  
FIRENZE  
Scuola di  
Architettura

**iCAD**

INTERNATIONAL COURSE ON  
ARCHITECTURAL DESIGN

# EXTERIOR SOLAR CONTROL- MORFOLOGY





UNIVERSITÀ  
DEGLI STUDI  
FIRENZE  
Scuola di  
Architettura



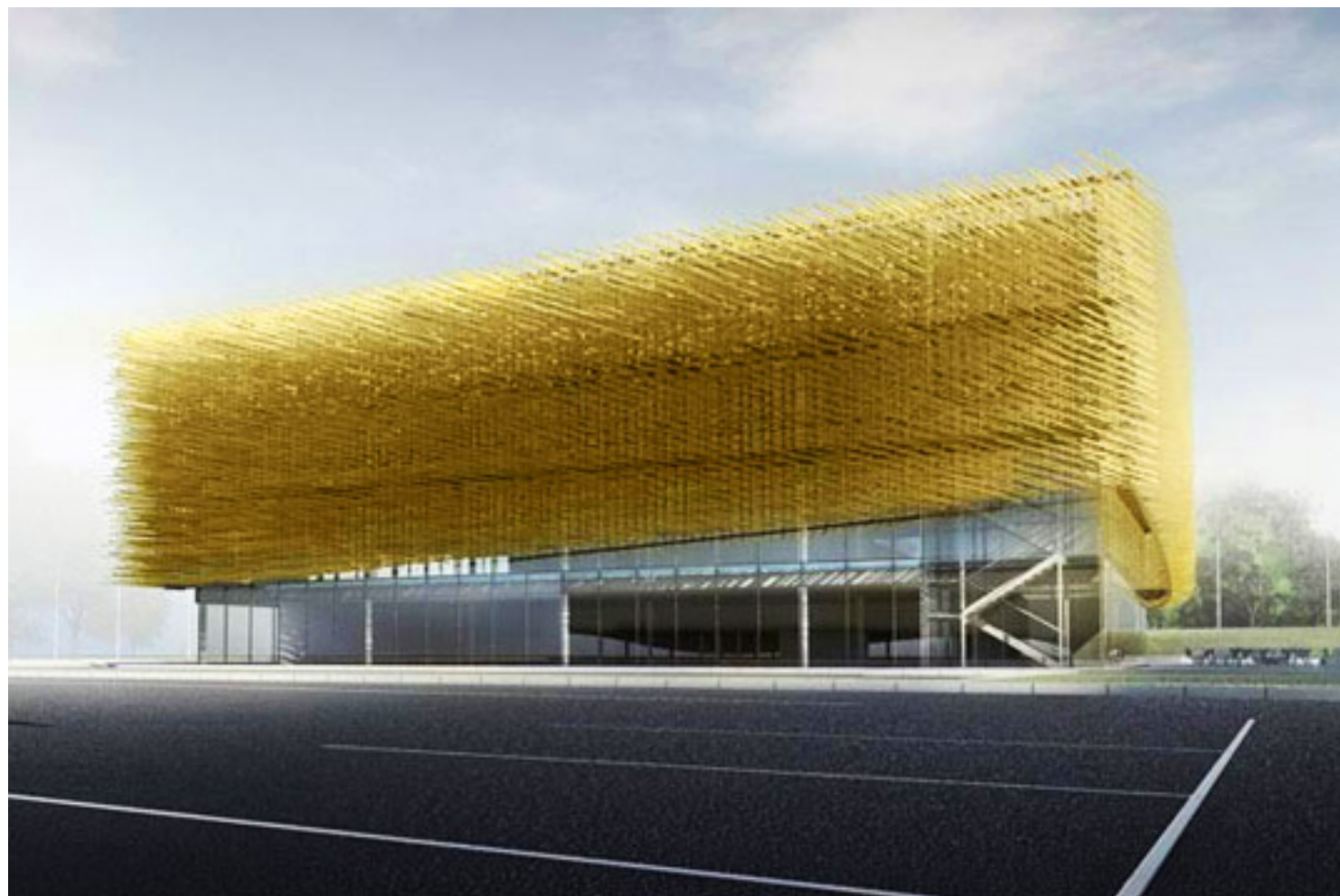
INTERNATIONAL COURSE ON  
ARCHITECTURAL DESIGN

# EXTERIOR SOLAR CONTROL- MORFOLOGY



Wessex Water Operations Center, Bath, UK,  
Bennett Architects





### [Prickly Porcupine Office Cleared for Construction](#)

[Passive solar](#) design meets pointillist pincushion in this stunning porcupine-inspired office recently cleared for construction in Prestons, England. Designed by UK-based [Moxon Architects](#), the building features a bristling [brise-soleil](#) composed of anodized aluminum fins suspended from tensile rods. This striking facade acts as a rain screen while filtering [sunlight](#) and contributing to the building's [energy-efficient](#) profile.

Dubbed Oliver's Place Preston, the 40,000 square foot [office building](#) won a competition organized by [RIBA](#) in 2007. Its innovative facade is formed from an array of aluminum "reeds" that are all arranged in the same direction. Their placement has been carefully considered such that "early morning and winter sunlight is able to enter the building while high summer sun is excluded and so does not adversely alter the environmental conditions within the building. The aluminium fins also appear as a thicket of material that gives the building a striking appearance that changes dramatically depending on the position of the viewer."

[+ Moxon Architects](#)

Read more: [Prickly Porcupine Office Cleared for Construction hedgehog-ed03 - Gallery Page 0 – Inhabitat - Sustainable Design Innovation, Eco Architecture, Green Building](#)



UNIVERSITÀ  
DEGLI STUDI  
FIRENZE  
Scuola di  
Architettura



INTERNATIONAL COURSE ON  
ARCHITECTURAL DESIGN

# EXTERIOR SOLAR CONTROL- MORFOLOGY





UNIVERSITÀ  
DEGLI STUDI  
FIRENZE  
Scuola di  
Architettura

**iCAD**

INTERNATIONAL COURSE ON  
ARCHITECTURAL DESIGN





UNIVERSITÀ  
DEGLI STUDI  
FIRENZE  
Scuola di  
Architettura



INTERNATIONAL COURSE ON  
ARCHITECTURAL DESIGN

# EXTERIOR SOLAR CONTROL- MORFOLOGY





UNIVERSITÀ  
DEGLI STUDI  
FIRENZE  
Scuola di  
Architettura

**iCAD**

INTERNATIONAL COURSE ON  
ARCHITECTURAL DESIGN

# EXTERIOR SOLAR CONTROL- MORFOLOGY



Kunsthalle, Bregenz,  
Austria by Peter Zumthor.



This is a building that most of you architects would certainly be familiar with: the Kunsthalle in Bregenz, Austria, a building by Peter Zumthor. A very simple idea, a concrete frame building very carefully made on the inside with the exterior of the building wrapped around this internal frame. The circulation for the building is inserted into the cavity between the layered or lapped glass skin and the concrete frame of the building. One sees the people walk up through and behind this skin, all the circulation is around the perimeter and you proceed into the exhibition spaces, inside the building. A very remarkable object that is a perfect cube, a cube of ice that sits on the lake in Bregenz and the construction of it is such that there are very large lights and they are lapped in both directions, meaning lapped both horizontally and vertically, the intent here is that the skin is again providing a simple thermal buffer between the exterior climate and the interior climate. There is obviously a great deal of ventilation going through the lapping of the glass panels, as well as venting at the top.

Again, in an animated way, this building activates itself within its urban environment by allowing for the presence of the visitors to be visible on the exterior of the building. In the evening, when it is all lit up and you have people moving through it, the building becomes an extraordinary lively object and I think this idea of reinforcing the participation of the building in its urban environment rather than isolate itself from the urban environment

Library Museum with  
ceramic fritting by Herzog/  
deMeuron.



This is a Herzog / de Meuron project, which uses ceramic fritting. We are all familiar with an effort to reduce the light transmission of the glass itself, but in this case they are using the fritting pattern not as some abstract dot pattern, or linear pattern but they are quite literally imposing images of a collection (this is actually a library museum) and they have basically taken elements from the collection itself and imposed them on the surface of the building so it becomes a way of combining an informational role in terms of the building as well as its weather proofing and its enclosure for environmental performance simultaneously.

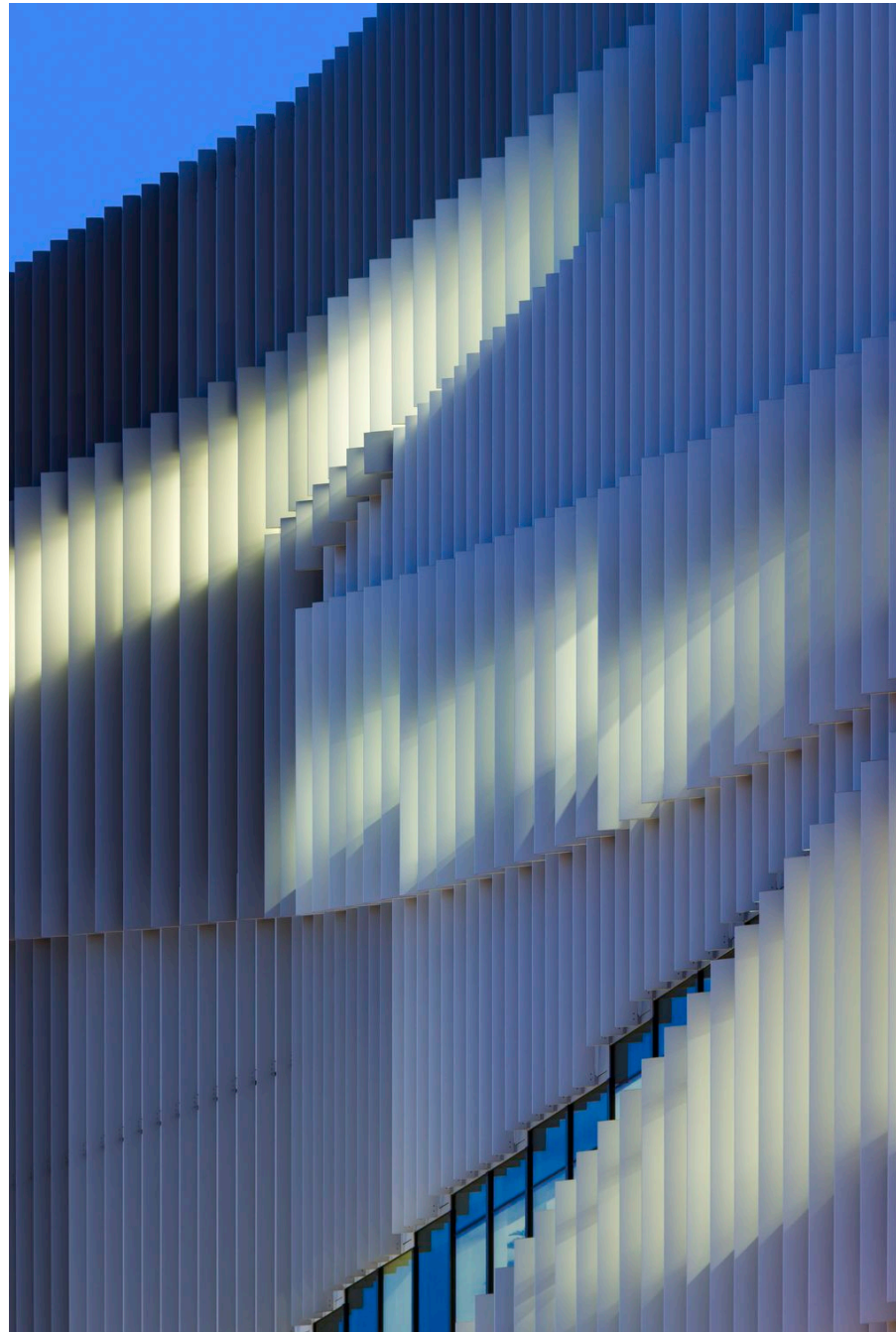
So I think there is this other level of thinking about double walls that we did not get into today as much as we might have, which is this drive for pursuing and exploring transparency and luminosity as a means to communicate the buildings' function which is something that has been lost in much architecture in recent years. The communication often is relied on in more historical attitudes or styles, where now I think we are re-embracing a modernist idea where you can let the building speak to the complexities of image and information that we are surrounded with through all different media.

This is an unusual building that is built out of regulex glass. These are structural glass "C" channels used predominately for industrial buildings. In this case, these regulex elements and the main office part of the building sleeve each other to form a double wall construction for the insulative characteristics.

This question of whether it is fashion, aesthetic, or purely thermal performance has to do with the rationalization of the cost for these systems. If they are seen exclusively as a mechanical device to improve performance, it is, as we all know, an almost impossible task to justify these walls financially over a short period of time. It takes a very, very long period of time for these systems to pay back their initial cost. However, if the design is coupled with a stronger position of the aesthetic and how it is operating in a broader social way, I think that the payback is a secondary question rather than a primary question. In order for us to explore these walls in this country, there will always have to be a broader base upon which to justify cost. We are never going to be able to make the case with our energy being so cheap that these systems can pay themselves back in any sort of a short time frame.

## FRITTED GLASS

the porosity  
obtained in the  
glass increases  
its insulation  
performance





UNIVERSITÀ  
DEGLI STUDI  
FIRENZE  
Scuola di  
Architettura

**iCAD**

INTERNATIONAL COURSE ON  
ARCHITECTURAL DESIGN

# EXTERIOR SOLAR CONTROL- MATERIALS

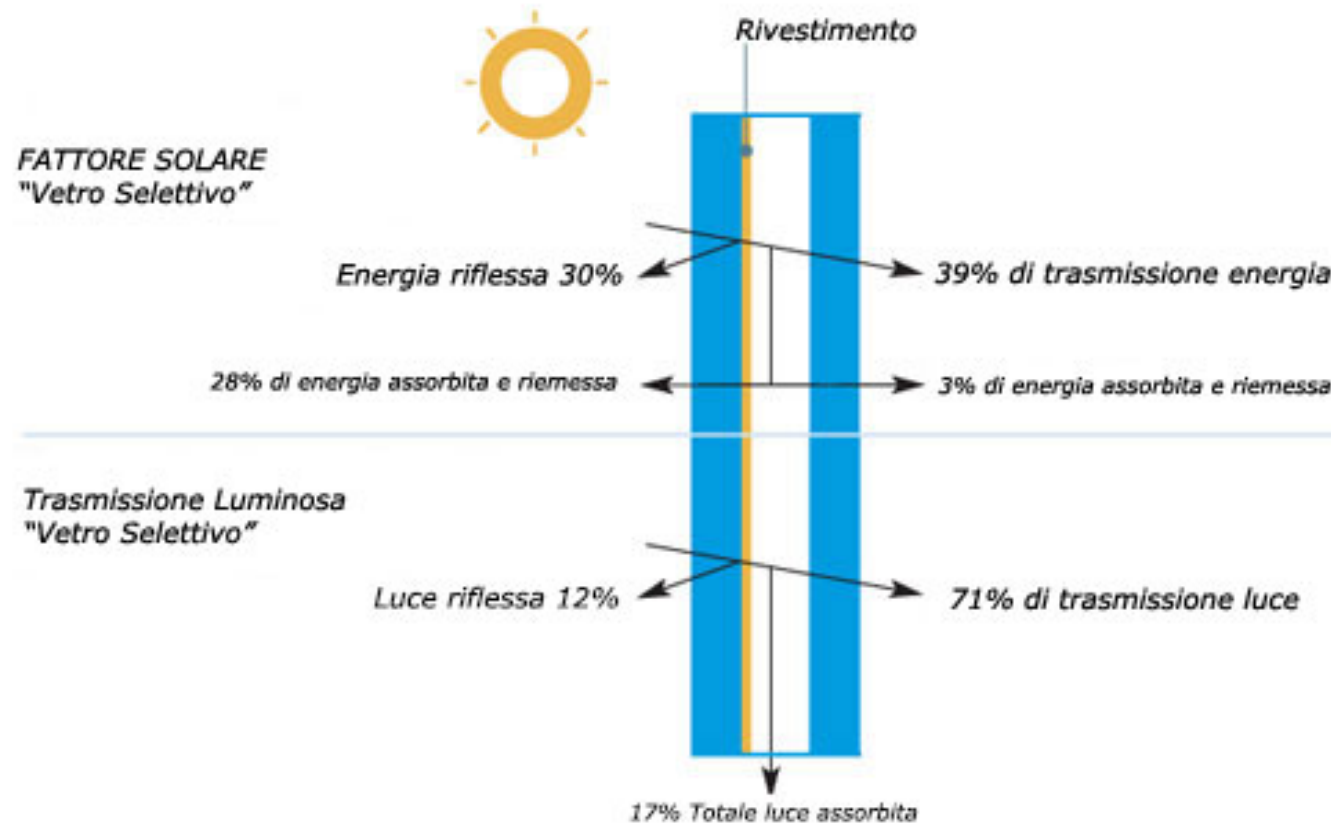
## REFRACTIVE GLASS

Refractive glass wall, First  
Bank Place, Hawaii,  
James Carpenter Design  
Associates.





## SELECTIVE GLASS



## HOE– Holographic Optical Element

Holographic optical elements (HOE) can also be applied to the redirection of zenithal sky-light. Tilted glass HOE overhangs can be placed over north-facing windows so that diffuse daylight is redirected into the building interior. The luminance level of the zenith region of an overcast sky (directly overhead) is typically much higher than horizon-level sky-light, therefore making this a promising strategy. The HOE glazing is still under development.



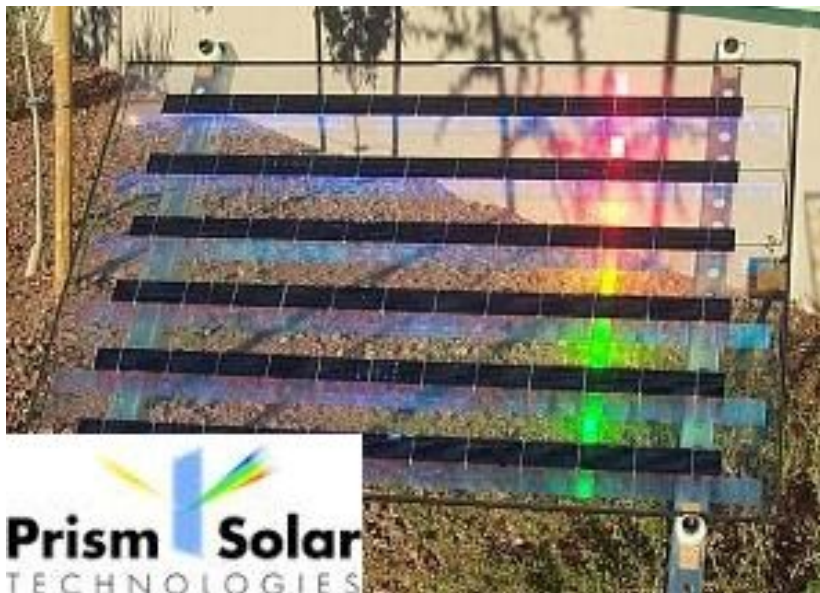
Laser-cut acrylic panel

serrated on one side forming prisms or sawtooth linear grooves across the face of the panel. The angles of two sides of the prism are engineered to block certain angles of sunlight and refract and transmit others. For some designs, one or both surfaces of the prism is coated with a high-reflectance aluminum film. The panels should be applied to the exterior of the building and should be adjusted seasonally to compensate for the variation in solar altitude.

Holographic optical elements (HOE) use the principle of diffraction to redirect sunlight. An interference pattern of any specification can be printed/stamped on a transparent film or glass substrate, then laminated between two panes of glass. Diffractive optical efficiency tends to be poor, but may improve as the technology is developed. The HOE technology is in a demonstration phase in Germany.

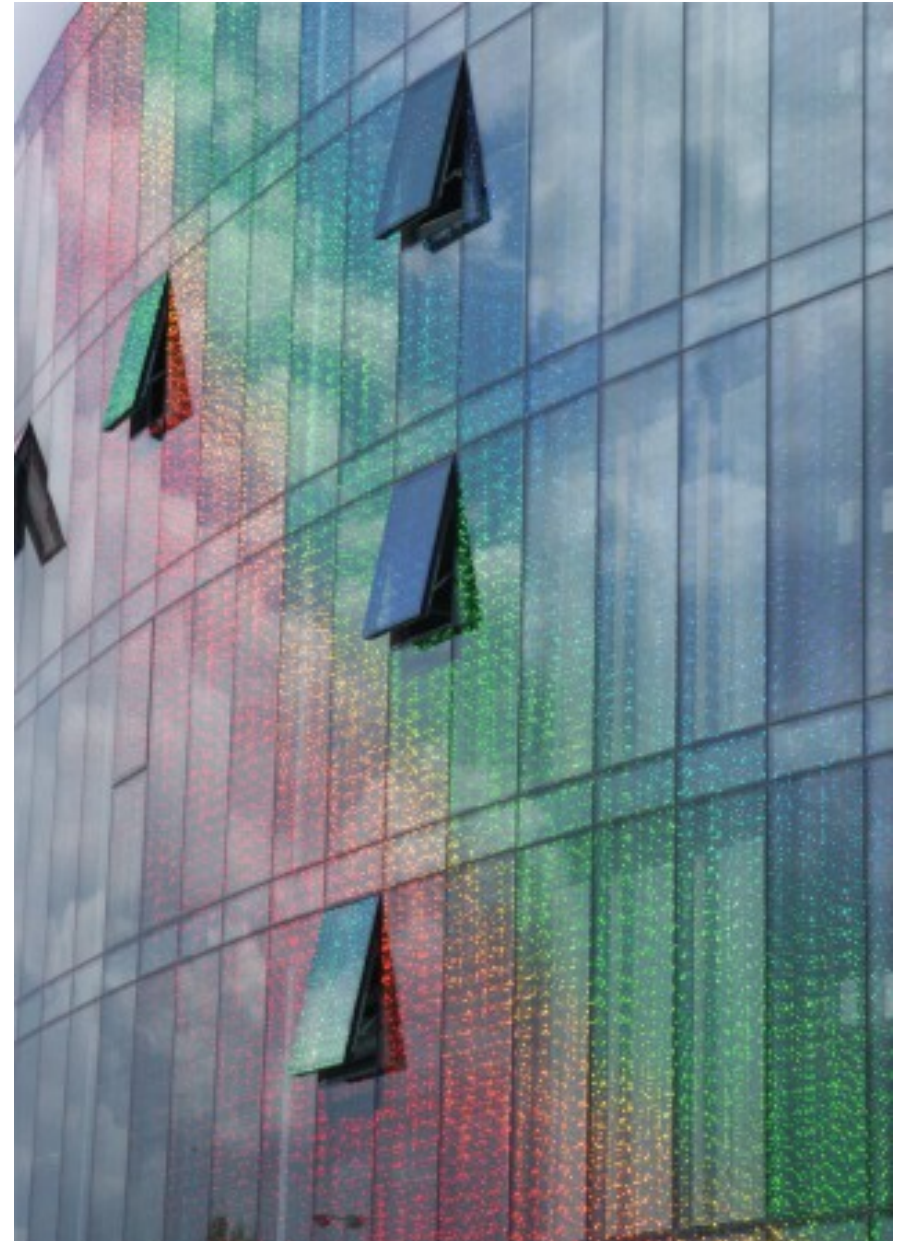
Sun-directing glass are long, slightly curved sections of glass that are stacked and placed between panes of glass. The refractive index of glass is again combined with geometry to redirect sunlight to the ceiling plane.

In all of the above systems, view is distorted or impaired so placement of such systems above standing view height is typically recommended. With many of the transparent systems, glare is not controlled since the direct sun increases the luminance of the panels well above acceptable limits for most office tasks.





**Eugenijus Miliunas, Siauliai Arena, Lithuania**





Their proposal of a fully glazed, transparent, elegantly decorated façade by way of outside cladding won Foreign Office Architects (FOA) the commission for the John Lewis Department Store at Leicester, England. The double curtain wall is of structural glass decorated by the "Ipachrome design" technique invented by Interpane. The effect is thus both ornamental and functional, since the spray process for applying the decoration gives effective protection against inquisitive eyes and sunrays, transmittance being a mere 4%. The lace-like coating is back-lit by night in a range of 256 colours. Structural glass gives the façade an especially harmonious appearance, as well as some practical advantages: for example, rainwater washes off all traces of dirt. In all, the glazed surface is 5,000 sq m. made up of 625 panes each measuring 2.4x5.4 m. The pattern helps disguise the joints and give the impression of one piece. For the outside the multilayer system designed by Ipachrome has the look of a brightly reflecting, silver-backed mirror. Unlike other reflecting surface cladding, it is highly resistant to damp and humidity.



UNIVERSITÀ  
DEGLI STUDI  
FIRENZE  
Scuola di  
Architettura

**iCAD**

INTERNATIONAL COURSE ON  
ARCHITECTURAL DESIGN

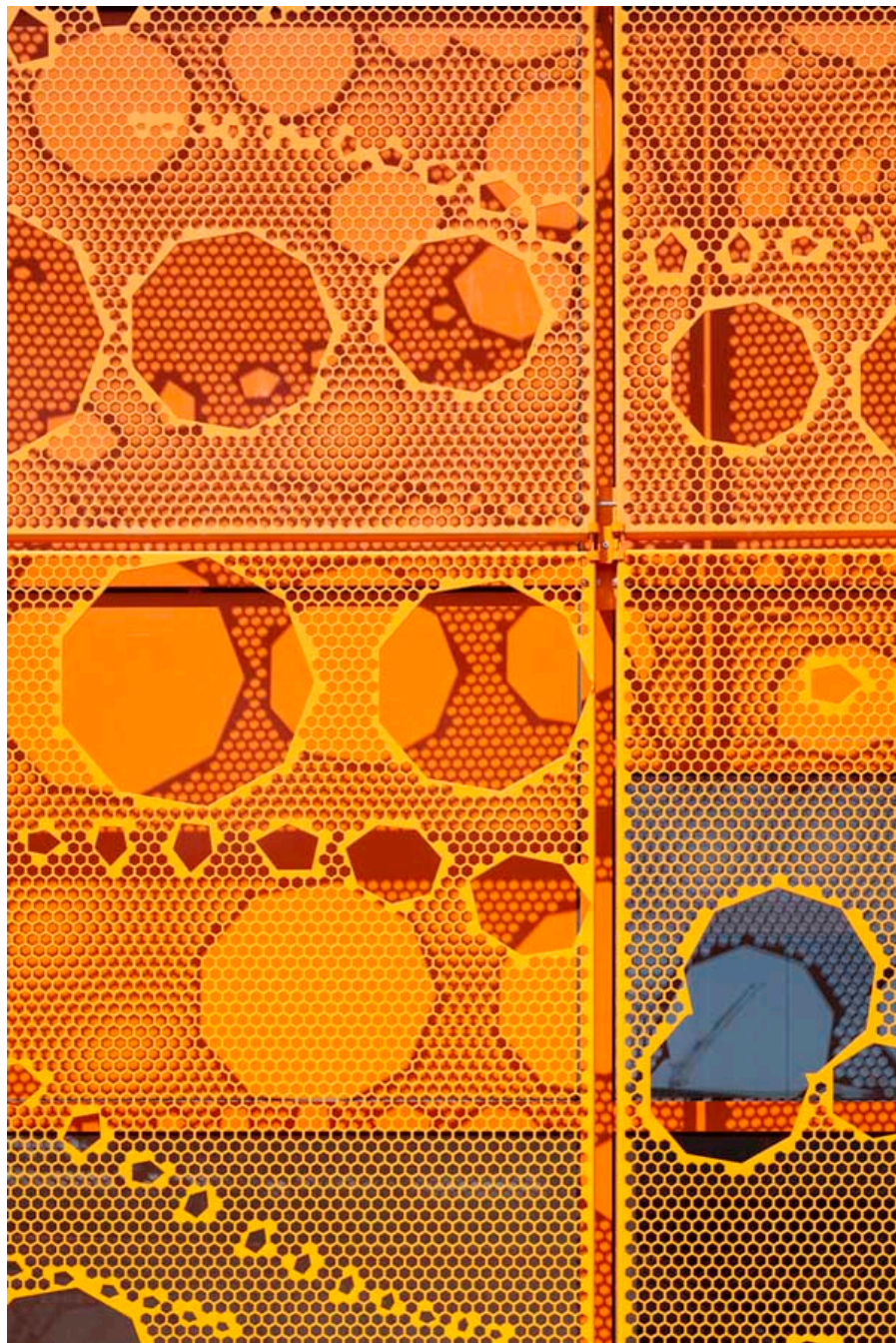




UNIVERSITÀ  
DEGLI STUDI  
FIRENZE  
Scuola di  
Architettura

**iCAD**

INTERNATIONAL COURSE ON  
ARCHITECTURAL DESIGN





UNIVERSITA'  
DEGLI STUDI  
FIRENZE  
Scuola di  
Architettura



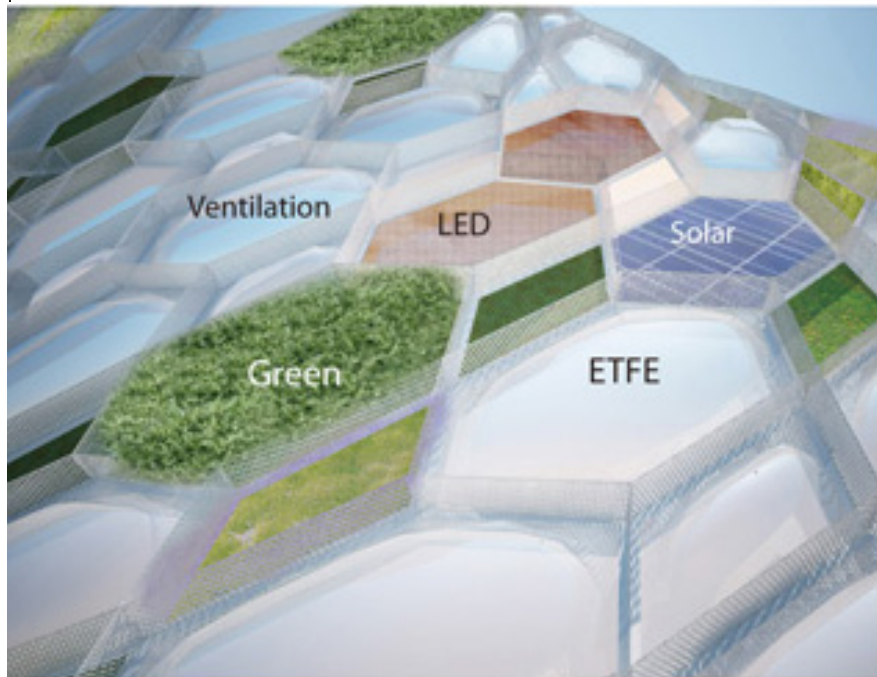
INTERNATIONAL COURSE ON  
ARCHITECTURAL DESIGN

# EXTERIOR SOLAR CONTROL- MATERIALS

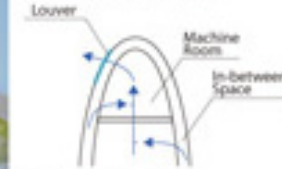
## CERAMIC FINISHING



# EXTERIOR SOLAR CONTROL- MATERIALS



## Ventilation System



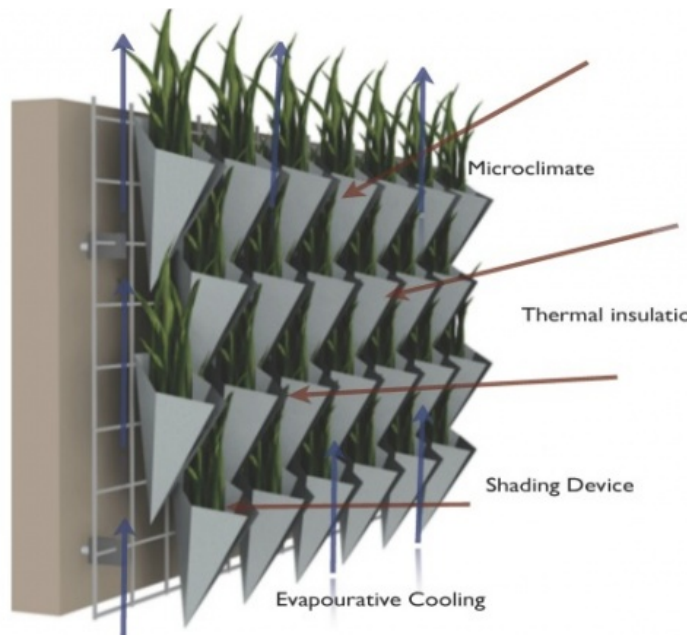
## Energy Saving using the Solar Panel



## Property of the ETFE



- cutting off the sun light
- easy maintenance
- light material
- durable material







Leaf-Facade-Mayfair-Squire-and-Partners



UNIVERSITÀ  
DEGLI STUDI  
FIRENZE  
Scuola di  
Architettura

**iCAD**

INTERNATIONAL COURSE ON  
ARCHITECTURAL DESIGN

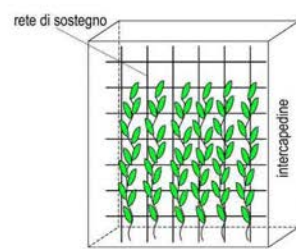
# EXTERIOR SOLAR CONTROL- MATERIALS



- installazione di essenze vegetali su stecche verticali ruotanti (si veda Fig. 1). Il  $\alpha$  della posizione può essere regolato con la stessa modalità adottata per gli schermi convenzionali. Gli svantaggi di questa soluzione sono: elevati costi relativi costruzione dei dispositivi mobili con le piante; intercapedine profonda; selezione delle piante; le essenze vegetali hanno infatti bisogno di essere resistenti ai cambi costante della loro posizione.
- installazione di piante su una grata fissa nell'intercapedine, in questo modo si ottiene la minima illuminazione richiesta degli ambienti interni (si veda Fig. 2). L'efficacia di questa soluzione può essere confrontata all'installazione degli schermi fissi estivi. Il vantaggio è una costruzione semplice della facciata. Possibile svantaggio è l'alta manutenzione dovuta alla frequente potatura delle piante. A causa di ciò è più opportuno adottare piante caratterizzate da una lenta crescita.

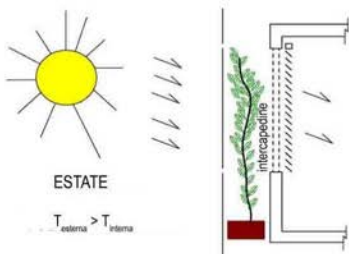


**Fig. 1** - Installazione di piante nell'intercapedine della facciata attraverso la loro disposizione in fioriere su stecche ruotanti. (Fonte: W.G. Stec, A.H.C., Van Paassen, A. Maziarz. Disegno rielaborato dall'autore.)

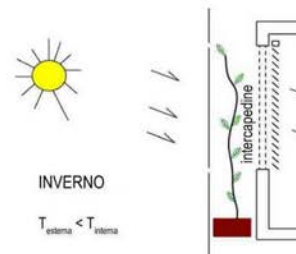


**Fig. 2** - Installazione di piante su una grata fissa nell'intercapedine della facciata. (Fonte: W.G. Stec, A.H.C., Van Paassen, A. Maziarz. Disegno rielaborato dall'autore.)

- adozione di piante decidue nell'intercapedine della facciata a doppia pelle. In autunno le piante perdono le foglie; creando una sorta di sistema di schermatura che regola. In inverno la radiazione solare passante attraverso la facciata produce calore che compensa le dispersioni termiche. In estate invece le piante bloccano gran parte della radiazione solare diretta permettendo allo stesso tempo l'illuminazione naturale degli ambienti interni. Ciò dà anche un effetto psicologico positivo agli utenti all'interno dell'edificio, poiché essi osservano continuamente il cambio delle stagioni nel loro lavoro. La Fig. 3 e la Fig. 4 mostrano le prestazioni di tale facciata nel periodo invernale e in quello estivo.

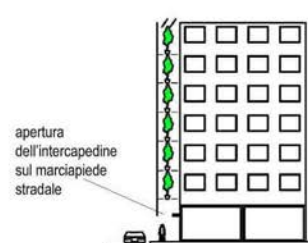


**Fig. 3** - Prestazioni della facciata con gli schermi vegetali nel periodo estivo. (Fonte: W.G. Stec, A.H.C., Van Paassen, A. Maziarz. Disegno rielaborato dall'autore.)

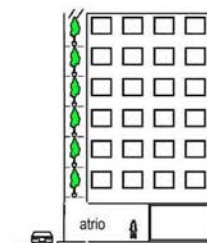


**Fig. 4** - Prestazioni della facciata con gli schermi vegetali nel periodo invernale. (Fonte: W.G. Stec, A.H.C., Van Paassen, A. Maziarz. Disegno rielaborato dall'autore.)

Lo svantaggio di questa soluzione è un possibile aumento della manutenzione relativa alla rimozione delle foglie morte. La Fig. 5 e la Fig. 6 suggeriscono soluzioni per questo problema. L'intercapedine può essere semplicemente aperta nella parte inferiore, permettendo facilmente alle foglie di cadere sulla pavimentazione esterna o interna di un edificio senza depositarsi sugli elementi che costituiscono la facciata. Le foglie possono infatti cadere sul pavimento di un atrio, creando l'impressione dell'autunno all'ingresso della costruzione.



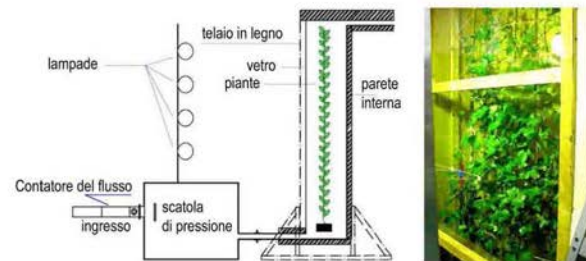
**Fig. 5** - Facciata doppia pelle con le piante. L'intercapedine è aperta, permettendo alle foglie di cadere sulla pavimentazione del marciapiede. (Fonte: W.G. Stec, A.H.C., Van Paassen, A. Maziarz. Disegno rielaborato dall'autore.)



**Fig. 6** - Facciata a doppia pelle con le piante. L'intercapedine è aperta alla base e consente alle foglie di cadere nell'atrio dell'edificio. (Fonte: W.G. Stec, A.H.C., Van Paassen, A. Maziarz. Disegno rielaborato dall'autore.)

### Misure delle prestazioni delle piante in una facciata doppia pelle

Per studiare la possibilità di applicare le piante nell'intercapedine di una facciata a doppia pelle, sono state eseguite da un gruppo di ricercatori dell'Università di Delft alcune prove nel modello di laboratorio che descrive una facciata a doppia pelle (Fig. 7). Tale modello è stato costruito con una struttura d'acciaio e legno e con una parete di vetro, mentre tutte le altre pareti sono state isolate con uno strato di polistirene spesso 50 o 100 mm.



**Fig. 7** - Modello di laboratorio della facciata a doppia pelle con le piante. (Fonte: W.G. Stec, A.H.C., Van Paassen, A. Maziarz. Disegno rielaborato dall'autore.)

La parete isolata del modello definisce la pelle interna della facciata di un edificio, invece il fronte vetrato realizza la pelle più esterna di vetro della chiusura perimetrale. La parete interna e la pelle di vetro delimitano un condotto d'aria in cui è stato disposto il dispositivo schermante. Per simulare la luce del sole sono state usate apposite lampade. La radiazione incidente sulla superficie del modello di laboratorio può essere controllata nell'intervallo di 46-206 W/m<sup>2</sup> in funzione del numero di lampade accese. Nel modello di laboratorio sono state installate 36 termocoppie per esaminare la distribuzione della temperatura. La

misurazione del flusso termico è stata realizzata con l'uso di un box a pressione e con tester di misurazione del flusso connesso all'ingresso del modello di laboratorio. Inoltre è stato misurato l'aumento di umidità nell'aria mediante un analizzatore di gas, che consente di determinare il rischio di condensazione sulle pareti della facciata.

Lo scopo primario della realizzazione del modello di laboratorio è stato quello di confrontare l'effetto di un sistema di ombreggiatura differente da quelli tradizionali nel comportamento della facciata e di determinare l'aumento di umidità dell'intercapedine.

L'effetto di differenti dispositivi di ombreggiatura nel comportamento della facciata a doppia pelle è stato osservato considerando i seguenti tre casi:

- nessun dispositivo di ombreggiatura nell'intercapedine;
- piante installate nell'intercapedine;
- schermi tradizionali installati al posto delle piante.

### Risultati conseguiti

La tabella 1 mostra il confronto dell'aumento di temperatura in ogni strato del modello di laboratorio per ognuno dei tre casi considerati.

Sistemi di schermatura	Strato ( $\Delta T = T_{strato} - T_{ambiente}$ [K])				
	Vetro esterno	Intercapedine esterna	Schermo	Intercapedine interna	Parete interna
Nessun schermo	15.0	8.6	7.9	8.0	10.7
Piante	14.2	8.5	6.4	5.5	6.9
Schermi tradizionali	15.1	10.8	12.7	8.3	8.6

**Tab. 1 - Differenza di temperatura misurata tra ogni strato del modello di laboratorio e l'ambiente.** (Fonte: W.G. Stec, A.H.C., Van Paassen, A. Maziarz. Tabella rielaborata dall'autore.)

Durante le misurazioni le quattro lampade sono state accese emettendo 206 W/m<sup>2</sup> di radiazione sul fronte vetrato del modello. In generale si è osservato che l'aumento di temperatura più basso si ottiene con le piante installate nell'intercapedine. Specialmente interessante è il confronto della temperatura degli schermi e delle piante. L'aumento di temperatura degli schermi è stato infatti circa due volte più elevato di quello delle foglie intercettate dalla stessa radiazione incidente. Una temperatura più bassa del sistema ombreggiatura ha come conseguenza l'abbassamento della quantità di calore trasferita alla parete interna e all'intercapedine d'aria.

Dalle misurazioni effettuate l'aumento di temperatura della parete interna è stato più basso di circa il 20% nell'intercapedine con le piante che in quella con gli schermi tradizionali. Inoltre l'aumento di temperatura dell'intercapedine d'aria è stato anche significativamente più basso (20-35%) per i sistemi con le piante rispetto a quelli con le schermature tradizionali, così pure la temperatura media nell'intercapedine con le piante è stata minore di quella misurata senza alcun elemento schermante nella facciata a doppia pelle.

Infine si è notato che l'evaporazione dell'acqua dalle foglie dipende dalla radiazione solare incidente sulla pianta e anche dalla quantità di acqua trasportata alla pianta. Quando le essenze vegetali ricevono un abbondante apporto idrico, la traspirazione e quindi l'evaporazione dell'acqua dalle foglie è elevata. In generale l'aumento osservato dell'umidità assoluta è stato dell'ordine di 0,5-1,8 g/kg. Se la temperatura si mantiene costante, tale valore potrebbe creare il rischio di condensazione sulla superficie della facciata quando l'umidità relativa iniziale è maggiore del 70-80%. Considerando che nel periodo estivo la temperatura dell'aria aumenta all'interno dell'intercapedine, l'umidità relativa finale non dovrebbe aumentare significativamente.

Il modello di simulazione della facciata a doppia pelle con le piante e quello con gli schermi tradizionali elaborato da Stec<sup>4</sup> ed è stato adottato per individuare le diverse prestazioni di queste facciate. Le misurazioni effettuate sul modello di laboratorio, realizzato alternativamente con le due varianti del sistema di ombreggiamento, hanno mostrato il vantaggio dell'applicazione delle piante nell'intercapedine delle facciate a doppia pelle rispetto all'installazione di schermi tradizionali. Entrambe le soluzioni di facciata a doppia pelle hanno le stesse caratteristiche a parte quelle del sistema di ombreggiamento; ciò ha evidenziato che

Di conseguenza l'accumulo più basso di energia termica nell'interstizio con le piante rende questa soluzione più adatta alle condizioni estive perché le essenze vegetali definiscono un sistema di protezione solare con un maggiore effetto ombreggiante.

Le simulazioni effettuate nel modello di laboratorio hanno infine mostrato che la capacità del sistema impiantistico di raffreddamento e il consumo di energia annuale sarebbe ridotto per gli edifici con le piante disposte nell'intercapedine della facciata a doppia pelle. Infatti nella Tab. 2 viene confrontata la prestazione di un sistema impiantistico HVAC (Heating Ventilating Air Conditioning) impiegabile in edifici caratterizzati da una facciata a doppia pelle realizzata con essenze vegetali e con schermi nell'intercapedine. Si può osservare che per la soluzione della facciata a doppia pelle con le piante, la capacità del sistema impiantistico HVAC è ridotta di circa il 18% e il consumo di energia per il raffreddamento è più basso di circa il 19%. Nel periodo estivo infatti l'aria più fredda nell'intercapedine è utilizzabile per un tempo più lungo per ventilare le stanze, riducendo il tempo di funzionamento del ventil-convettore approssimativamente del 10%. Dall'altro lato il tempo di funzionamento del ventil-convettore viene aumentato per il periodo invernale.

### Conclusioni

Questo studio ha analizzato le prestazioni termiche di una facciata a doppia pelle con le piante disposte nell'intercapedine. La simulazione di questo sistema di facciata è stata sperimentata con la realizzazione di un modello in laboratorio che è stato impiegato per confrontare le prestazioni sia di una facciata a doppia pelle con le piante, che della stessa dotata invece di schermature nell'intercapedine.

Si è così potuto osservare che le piante realizzano un sistema di ombreggiamento effettivamente maggiore. Sono stati infatti verificati alcuni aspetti vantaggiosi nell'uso delle piante nell'intercapedine, come:

- La temperatura di ogni strato della facciata a doppia pelle è in generale più bassa per il caso con le piante rispetto a quello con gli schermi. Sotto la stessa radiazione incidente l'aumento di temperatura della pianta è stato di circa due volte più basso di quello di uno schermo tradizionale. Inoltre la temperatura della pianta (*hedera helix*) non eccede mai la temperatura di 35°C, mentre gli schermi possono superare i 55°C.
- L'installazione delle piante nella doppia facciata permette nel periodo estivo la riduzione della capacità di raffreddamento di quasi il 20% dei sistemi impiantistici, con conseguenti risparmi energetici.
- L'influenza delle piante sul sistema di riscaldamento non è stata osservata in questo studio. Le piante quindi potrebbero causare un aumento della domanda di energia per il riscaldamento negli edifici rispetto al sistema con gli schermi.
- L'uso di piante nella facciata a doppia pelle per la ventilazione naturale è in grado di ridurre il tempo di funzionamento della ventilazione meccanica nel periodo caldo e aumentare il tempo di funzionamento nel periodo freddo.

In conclusione i vantaggi dell'impiego delle essenze vegetali, come sistema di ombreggiatura nell'intercapedine di una facciata a doppia pelle, sono di contribuire a ridurre il consumo energetico di un edificio. Tale considerazione dovrebbe quindi essere uno stimolo per un nuovo modo di progettare e di realizzare gli edifici, finalizzato a far diventare le essenze vegetali un elemento del manufatto costruito.

### NOTE

<sup>1</sup> Campbell D., Gaylon S., Norman J. M., *Introduction to environmental biophysics*, (2 ed.), Springer, New York, 1998.  
<sup>2</sup> Pal A. K., Kumar V., Safena N. C., *Noise attenuation by green belts*, in "Journal of Sound and Vibration" n. 234, 2000, pp. 149-165.  
<sup>3</sup> Wolverton B. C., Johnson A., Bounds K., *Interior landscape plants for indoor air pollution abatement*, in "Interiorscape" n. 11, 1989, pp. 37-63.  
<sup>4</sup> Stec W., Van Paassen A.H.C., *Defining the performance of the double skin facade with the use of the simulation model*, in Building Simulation, Eindhoven, NL, 2003.

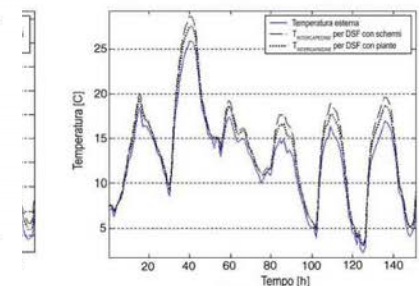
di questo tipo di chiusura verticale consentono come dimostrano i bassi valori di temperatura interna (Tab. 1) della facciata a doppia pelle con le piante durante le ore con un elevato irraggiamento

Prestazione dell'edificio	
<b>a doppia pelle [mi]</b>	<b>Facciata a doppia pelle con piante</b>
	0,117
m <sup>2</sup> a	25,00 [W/m <sup>2</sup> a]
m <sup>2</sup> a	57,50 [W/m <sup>2</sup> a]
h/m <sup>2</sup>	12,00 [kWh/m <sup>2</sup> ]
h/m <sup>2</sup>	13,35 [kWh/m <sup>2</sup> ]
	40,00 %
	72,90 %
	150

**Tab. 2 - Prestazione dell'edificio con la facciata a doppia pelle [DSF] con schermi e con le piante.** (Fonte: W.G. Stec, A.H.C., Van Paassen, A. Maziarz. Tabella rielaborata dall'autore.)

La soluzione di facciata a doppia pelle è anche un fattore determinante per il comfort interno. Sotto l'aspetto della facciata a doppia pelle con gli schermi tradizionali, il comfort degli ambienti interni, accompagnata da un sistema di climatizzazione nel periodo estivo (Tab. 2). In Fig. 8, le misurazioni effettuate hanno permesso di confrontare la temperatura degli schermi con quella delle piante nell'intercapedine della facciata a doppia pelle. Ancora due volte più piccolo di quello degli schermi tradizionali, le temperature dell'intercapedine e della parete interna

confrontate in Fig. 9, hanno consentito di confrontare le prestazioni di sistemi di ombreggiatura, evidenziando che l'uso delle piante è quasi due volte più piccolo di quello dei sistemi di schermature tradizionali.



**Fig. 8 - Valori della temperatura degli schermi e delle piante disposte nell'intercapedine della facciata a doppia pelle.** (Fonte: W.G. Stec, A.H.C., Van Paassen, A. Maziarz. Grafico rielaborato dall'autore.)

**Fig. 9 - Valori della temperatura dell'aria e della parete interna per la facciata a doppia pelle con gli schermi e con le piante.** (Fonte: W.G. Stec, A.H.C., Van Paassen, A. Maziarz. Grafico rielaborato dall'autore.)

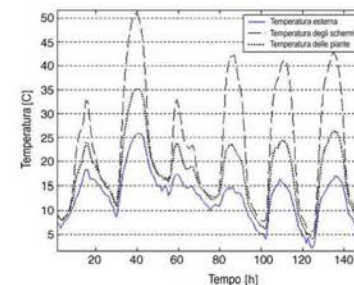
essenze vegetali disposte nell'intercapedine di questo tipo di chiusura verticale consentono di ottenere un'efficienza energetica maggiore come dimostrano i bassi valori di temperatura misurati sulla superficie della parete interna (Tab. 1) della facciata a doppia pelle con le piante. Tali valori sono osservabili specialmente durante le ore con un elevato irraggiamento solare.

	Prestazione dell'edificio	
	Facciata a doppia pelle con schermi	Facciata a doppia pelle con piante
Fattore G della facciata	0,121	0,117
Capacità termica	25,00 [W/m <sup>2</sup> a]	25,00 [W/m <sup>2</sup> a]
Capacità di raffreddamento	70,00 [W/m <sup>2</sup> a]	57,50 [W/m <sup>2</sup> a]
Consumo di energia		
- per riscaldamento	12,00 [kWh/m <sup>2</sup> ]	12,00 [kWh/m <sup>2</sup> ]
- per raffrescamento	16,20 [kWh/m <sup>2</sup> ]	13,35 [kWh/m <sup>2</sup> ]
ore di funzionamento dei ventil-convettori		
- in estate	44,70 %	40,00 %
- in inverno	70,80 %	72,90 %
ore di surriscaldamento	150	150

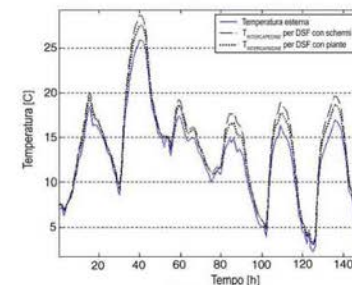
**Tab. 2** - Confronto delle prestazioni di una facciata a doppia pelle [DSF] con schermi e con le piante nell'intercapedine. (Fonte: W.G. Stec, A.H.C., Van Paassen, A. Maziarz. Tabella rielaborata dall'autore.)

Il risultato conseguito per questa soluzione di facciata a doppia pelle è anche un fattore di ombreggiatura solare G più basso rispetto alla facciata a doppia pelle con gli schermi tradizionali e una migliore condizione di comfort degli ambienti interni, accompagnata da un minore consumo energetico degli impianti di climatizzazione nel periodo estivo (Tab. 2). Inoltre, come si può osservare nel grafico di Fig. 8, le misurazioni effettuate hanno permesso di confrontare la temperatura degli schermi con quella delle piante nell'intercapedine. L'aumento di temperatura delle piante è ancora due volte più piccolo di quello degli schermi tradizionali, influenzando di conseguenza le temperature dell'intercapedine e della parete interna.

Infine le misurazioni effettuate, come è mostrato in Fig. 9, hanno consentito di confrontare la temperatura dell'intercapedine per entrambi i sistemi di ombreggiatura, evidenziando che l'aumento di temperatura nell'interstizio con le piante è quasi due volte più piccolo di quello che si registra nell'intercapedine con le schermature tradizionali.



**Fig. 8** - Valori della temperatura degli schermi e delle piante disposte nell'intercapedine della facciata a doppia pelle. (Fonte: W.G. Stec, A.H.C., Van Paassen, A. Maziarz. Grafico rielaborato dall'autore.)



**Fig. 9** - Valori della temperatura dell'aria per la facciata a doppia pelle con gli schermi e con le piante. (Fonte: W.G. Stec, A.H.C., Van Paassen, A. Maziarz. Grafico rielaborato dall'autore.)

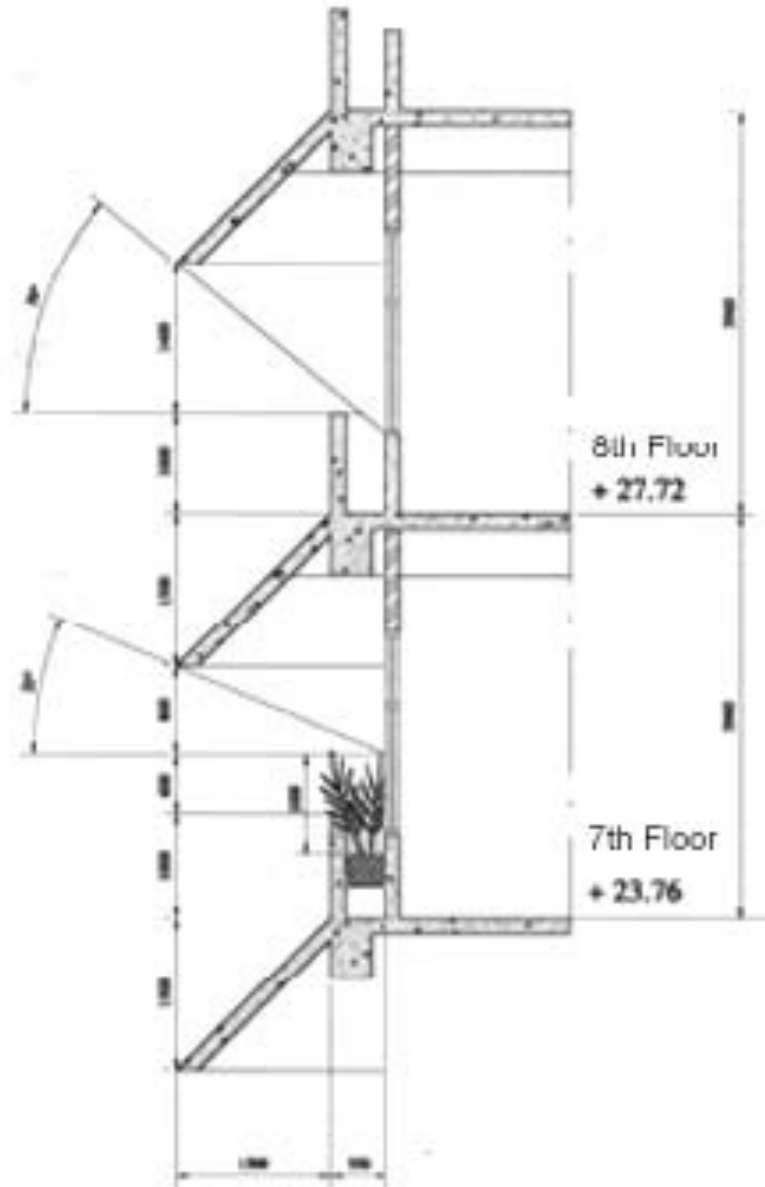


UNIVERSITÀ  
DEGLI STUDI  
FIRENZE  
Scuola di  
Architettura



INTERNATIONAL COURSE ON  
ARCHITECTURAL DESIGN

# EXTERIOR SOLAR CONTROL- GREEN





UNIVERSITÀ  
DEGLI STUDI  
FIRENZE  
Scuola di  
Architettura



INTERNATIONAL COURSE ON  
ARCHITECTURAL DESIGN

# EXTERIOR SOLAR CONTROL- GREEN





UNIVERSITÀ  
DEGLI STUDI  
FIRENZE  
Scuola di  
Architettura

**iCAD**

INTERNATIONAL COURSE ON  
ARCHITECTURAL DESIGN

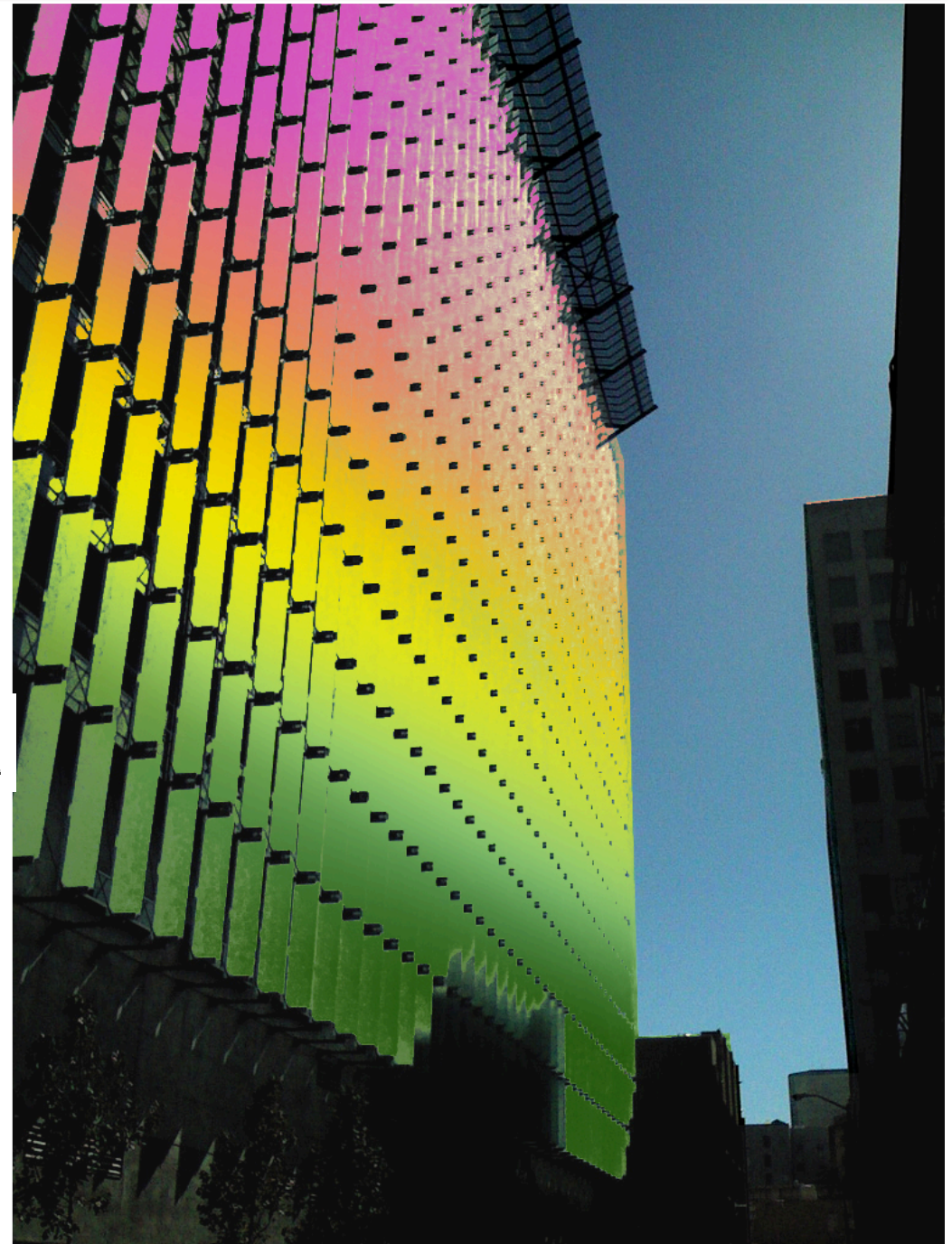
# EXTERIOR SOLAR CONTROL- GREEN



artificial wetlands. What if GMO algae strains were color coded to show the different strains of algae in the different phases of filtration? I think it would be beautiful after producing a concept image. So to wrap up this little experiment the resultant is a Light Filtering, CO2 absorbing, Greywater Purifying, Bioenergy producing Rainbow Beauty. The BIOS-FIN (Functionally



## CleanTick







UNIVERSITÀ  
DEGLI STUDI  
FIRENZE  
Scuola di  
Architettura



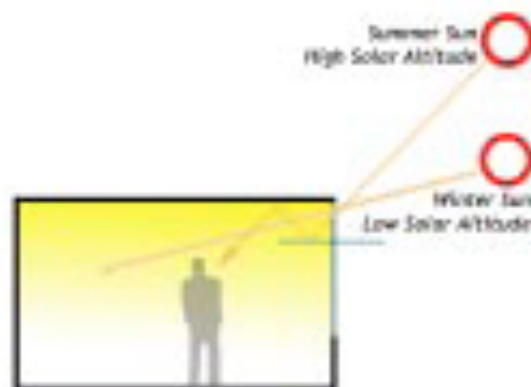
INTERNATIONAL COURSE ON  
ARCHITECTURAL DESIGN

# EXTERIOR SOLAR CONTROL- GREEN



ALGADISK - Novel  
algae-based solution  
for CO<sub>2</sub> capture and  
biomass production





*In summer, when the sun is high in the sky, lightshelves block direct sun at both the upper and lower windows. In winter, low sun can penetrate to the back of the space through the clerestory, pre-heating occupied space in the morning, and providing light when needed. Tinted glazing can be used at the lower view window, while clear glazing can be used at the clerestory to increase daylight admission.*

### Sky-light redirection

The second category of light-redirection systems designed for diffuse sky-light are effective for climates with predominantly cloudy conditions or for urban or other situations where the windows or skylights only “see” the sky. For such systems, the main design objective is to increase interior daylight levels overall with less emphasis on the depth of light redirection.

Anidolic systems use the principle of non-imaging optics to gather omnidirectional diffuse light and guide the flux with mirrored curved geometries. This “focused” daylight can then be redirected along the ceiling plane and distributed via light ducts into the interior. The collector optics are created using plastic injection moulds then coated with a high-grade aluminum coating.

Holographic optical elements (HOE) can also be applied to the redirection of zenithal sky-light. Tilted glass HOE overhangs can be placed over north-facing windows so that diffuse daylight is redirected into the building interior. The luminance level of the zenith region of an overcast sky (directly overhead) is typically much higher than horizon-level sky-light, therefore making this a promising strategy. The HOE glazing is still under development.

### Double-skin facades and natural ventilation

The double-skin façade is a European Union (EU) architectural phenomenon driven by the aesthetic desire for an all-glass façade and the practical desire to have natural ventilation for improved indoor air quality without the acoustic and security constraints of naturally-ventilated single-skin facades.

The foremost benefit cited by design engineers of EU double-skin facades is acoustics. A second layer of glass placed in front of a conventional façade reduces sound levels at particularly loud locations, such as airports or high-traffic urban areas. Operable windows behind this all-glass layer compromise

## Technological Solutions



Rock and Roll History  
Museum, Cleveland, Ohio

### Solar control facades

#### Spectrally selective solar control

Spectrally selective glazing is window glass that permits some portions of the solar spectrum to enter a building while blocking others. This high-performance glazing admits as much daylight as possible while preventing transmission of as much solar heat as possible. By controlling solar heat gains in summer, preventing loss of interior heat in winter, and allowing occupants to reduce electric lighting use by making maximum use of daylight, spectrally selective glazing significantly reduces building energy consumption and peak demand. Because new spectrally selective glazings can have a virtually clear appearance, they admit more daylight and permit much brighter, more open views to the outside while still providing much of the solar control of the dark, reflective energy-efficient glass of the past. They can also be combined with other absorbing and reflecting glazings to provide a whole range of sun control performance.

11

"[Ceramic frit glass] had a minor effect on the building's energy performance for the Blue Cross/Blue Shield Headquarters in Chicago (BD&C 10/98) but allowed extensive overhead glazing in the UA terminal at O'Hare in the late 1990s and to meet ASHRAE Standard 90... Most projects use white-colored frit. Frits do reduce the shading coefficient of the glass, but low-E coatings provides more effective reductions." *Building Design and Construction*, July 2000.



Ceramic-enamel coatings  
on glass

### Solar filters

Solar filters indiscriminately absorb or reflect a portion of both direct and diffuse solar radiation. Overhangs, fins, "lightselves", or a secondary exterior skin made of filter material are applied to south, east, or west-facing facades to cut down on incident solar radiation levels and diffuse daylight. Filters may be made with an opaque base material (woven or perforated, metal screens or fabric) or transparent base material (etched, translucent, or fritted glass or plastic).

Generally, the effectiveness of solar control is normally in proportion to the percentage of opaque material and will vary with the thickness, opacity, reflectance/absorptance of the material, and position within the façade. Interior fabric roller shades can provide modest solar heat gain control if its exterior-facing surface reflectance is high (white or semi-reflective). Translucent composite fiberglass panels (e.g., Kalwall) used as part of the window wall also provides modest solar control.

Between-pane absorptive shade systems, such as those used in double-skin facades, can also lead to thermal stress on the window system and to increased solar heat gain, if inadequately placed, due to the increased surface temperature of the absorbing shading layer. Localized solar absorptance can cause increased thermal stress and possible glass breakage with fritted glass.

The architectural trend over the past one to two decades has been to use filtering material (fritted and etched glass). Ceramic-enamel coatings on glass (fritted glass) rely on a pattern (dots, lines, etc.) to control solar radiation. The pattern is created by opaque or transparent glass fused to the substrate glass material under high temperatures. The substrate must be heat strengthened or tempered to prevent breakage due to thermal stress. A low-e coating can be placed on top of the frit. To reduce long-wave radiative heat gains, it's best to use the absorbing fritted layer as the exterior layer (surface #2) of an insulating glass unit.

Initially, filters were used in the non-view portions of the roof or window wall. There is an increased trend to use filters in the view portions of the window wall for aesthetic visual effect. Such use can impair view and increase glare significantly, particularly if backlit by direct sun, since the window luminance within one's direct field of view is significantly increased. Perforated blind systems provide solar control with daylight admission, and can improve visual comfort through the reduction of the luminance contrast at the window.

# SUN AND SKY LIGHT REDIRECTION

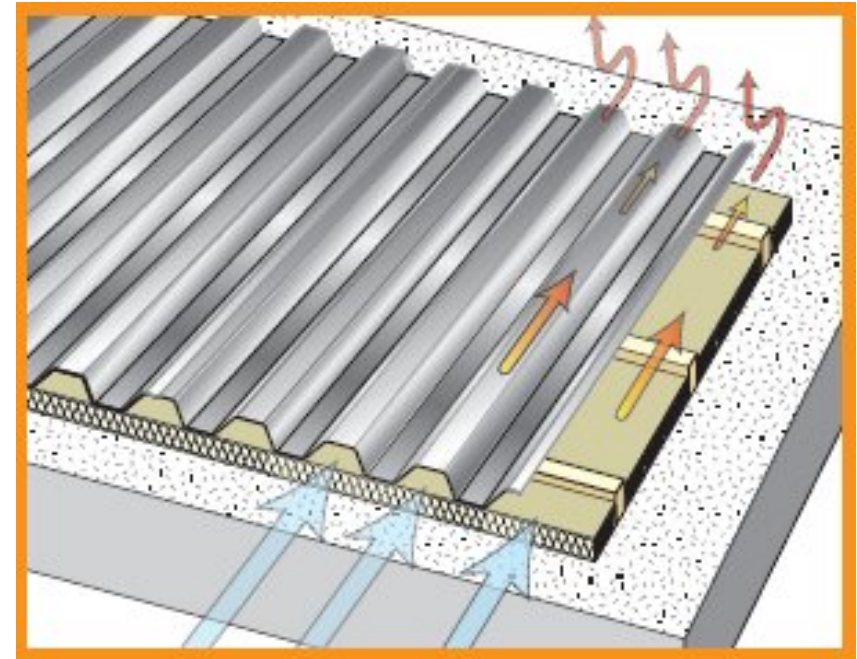
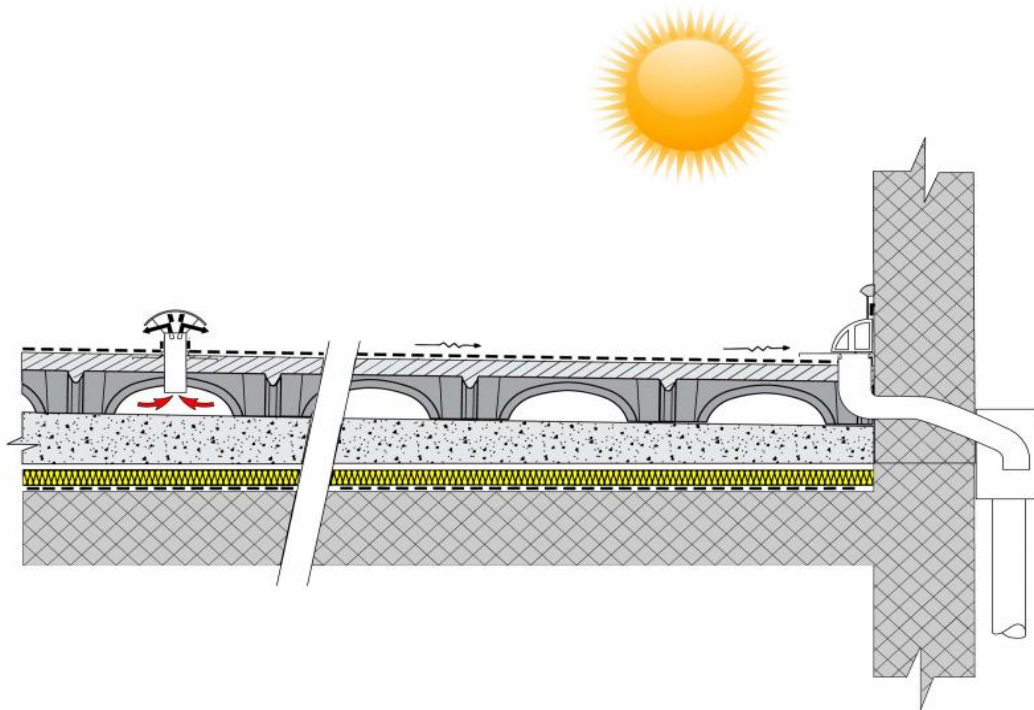
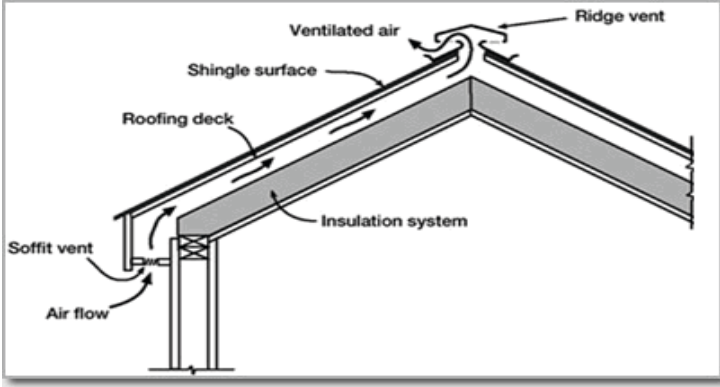
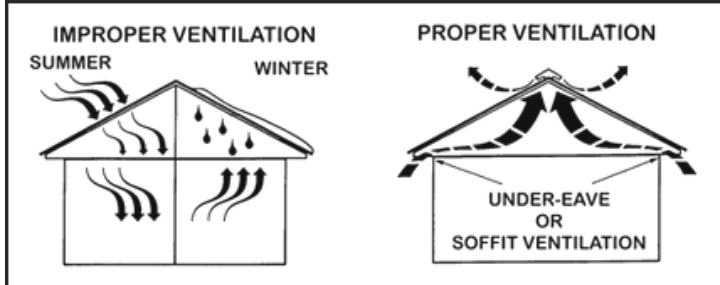
Automated louvers on a skylight system, Technology Museum, Berlin



Fiber-optic array, Technology Museum, Berlin



# VENTILATED ROOF



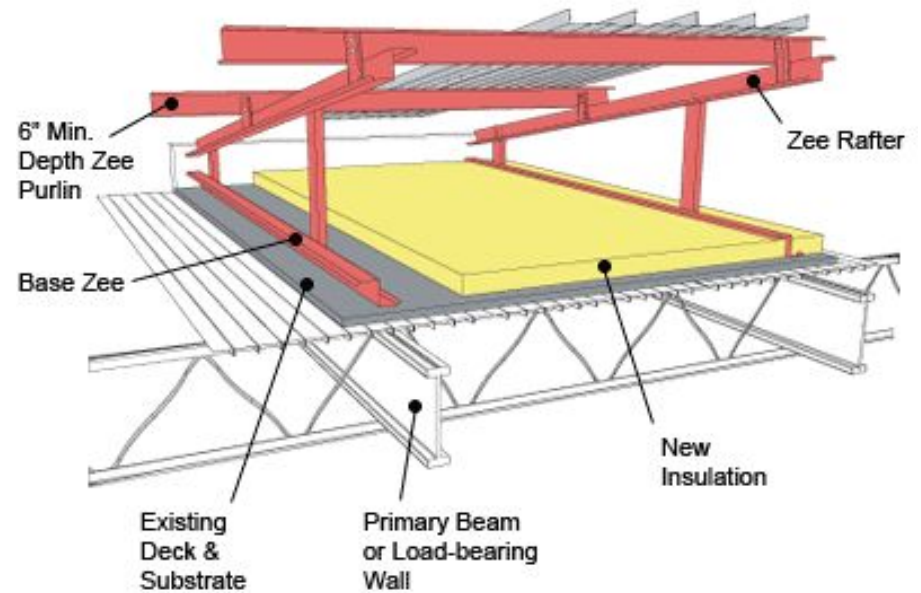


UNIVERSITÀ  
DEGLI STUDI  
FIRENZE  
Scuola di  
Architettura



INTERNATIONAL COURSE ON  
ARCHITECTURAL DESIGN

# VENTILATED ROOF





UNIVERSITÀ  
DEGLI STUDI  
FIRENZE  
Scuola di  
Architettura



INTERNATIONAL COURSE ON  
ARCHITECTURAL DESIGN

## DOUBLE ROOF – CANOPY





UNIVERSITÀ  
DEGLI STUDI  
FIRENZE

Scuola di  
Architettura

**iCAD**

INTERNATIONAL COURSE ON  
ARCHITECTURAL DESIGN

## DOUBLE ROOF – CANOPY







UNIVERSITÀ  
DEGLI STUDI  
FIRENZE  
Scuola di  
Architettura



INTERNATIONAL COURSE ON  
ARCHITECTURAL DESIGN

## DOUBLE ROOF – CANOPY



pamm prez art museum a miami herzog and meuron



UNIVERSITÀ  
DEGLI STUDI  
FIRENZE

Scuola di  
Architettura

**iCAD**

INTERNATIONAL COURSE ON  
ARCHITECTURAL DESIGN

# GREEN ROOF



ballard-library



Exterior overhangs, Nordic Countries Embassies, Berlin.



Exterior overhangs, Nordic Countries Embassies, Berlin.

One would expect that with the increasing number of buildings that feature advanced facades, a suite of design tools would be available that enables designers (architects and engineers) to determine the impact of advanced facades on building performance. Such tools do exist for many systems, but these tools are generally developed in-house and are proprietary and/or require significant engineering expertise and time that is disproportional to the resources of a conventional project. Many of these tools are used simply to provide performance estimates under the worst-case design conditions. Year-round performance is typically not modeled unless called for by the energy codes or requested by the exceptionally diligent client. Yet, the architectural literature claims increased energy efficiency, improved comfort, improved indoor air quality, etc. Since no post-occupancy field evaluations have been done, how are these claims substantiated?

Pragmatically, A/E firms are tasked to solve complex, multi-dimensional problems within short order to meet the demands of the client and the budget. In this section, we describe the basic concepts or algorithms that are used to predict the thermal and daylighting impacts of facades on building performance (i.e. energy use, comfort, HVAC design, etc.). We explain how models for high performance facades differ from basic algorithms, and describe the

## References

Brager, G.S., E. Ring, and K. Powell. 2000. Mixed-mode ventilation: HVAC meets Mother Nature. *Engineered Systems*. May 2000.

CIBSE. 1997. *Natural ventilation in non-domestic buildings: CIBSE applications manual AM10: 1997*. London: Chartered Institution of Building Services Engineers (CIBSE).

Ring, E. 2000. *Mixed-mode office building: A primer on design and operation of mixed-mode buildings and an analysis of occupant satisfaction in three California mixed-mode office buildings*. Thesis (M.S. in Architecture) Berkeley, California: University of California, Berkeley.

## Active Facades

Smart windows and shading systems have optical and thermal properties that can be dynamically changed in response to climate, occupant preferences and building energy management control system (EMCS) requirements. These include motorized shades, switchable electrochromic or gasochromic window coatings, and double-envelope macroscopic window-wall systems. "Smart windows" could reduce peak electric loads by 20-30% in many commercial buildings and increase daylighting benefits throughout the U.S., as well as improve comfort and potentially enhance productivity in our homes and offices. These technologies will provide maximum flexibility in aggressively managing demand and energy use in buildings in the emerging deregulated utility environment and will move the building community towards a goal of producing advanced buildings with minimal impact on the nation's energy resources. Customer choice and options will be further enhanced if they have the flexibility to dynamically control envelope-driven cooling loads and lighting loads.



Automated translucent glass louvers at the Environmental Building, Building Research Establishment, Garston, UK (see detailed case study).

## Demand-responsive programs

A variety of different strategies have been implemented by utilities and other their customers in attempts to manage and reduce electric load. Most have

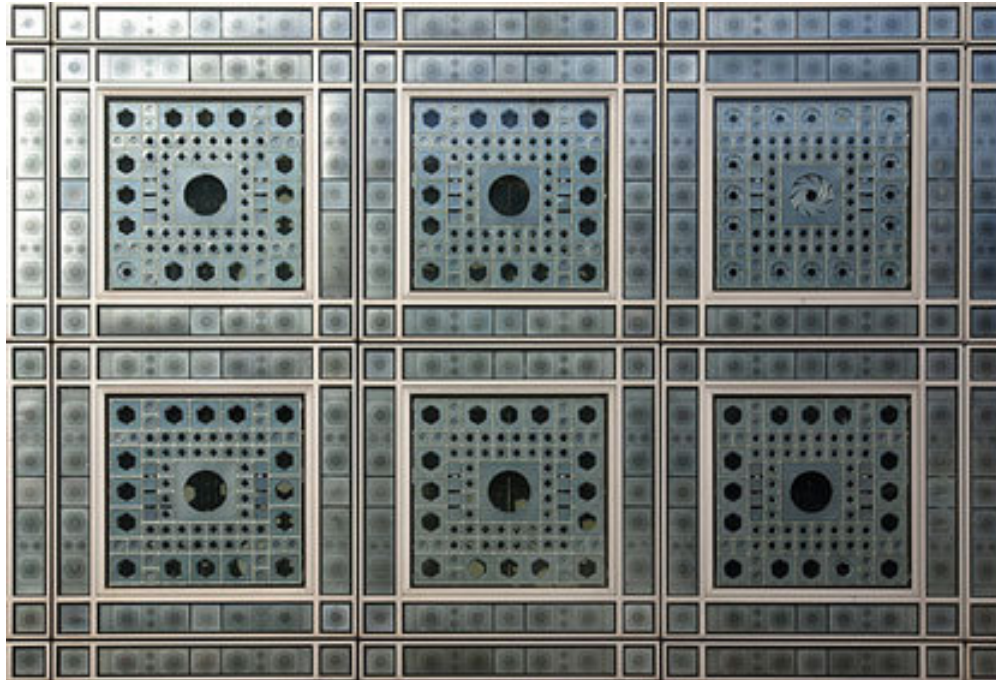


UNIVERSITA'  
DEGLI STUDI  
FIRENZE  
Scuola di  
Architettura



INTERNATIONAL COURSE ON  
ARCHITECTURAL DESIGN

# SOLAR & LIGHT CONTROL- ADAPTIVE SCREEN



Jean Nouvel, Institut du Monde Arabe, 1987



# ACTIVE GALLERY

Barcelona-Active-Gallery-Escolano-Ubach-01

(During the 60s an experimental bries soleil activated by quicksilver was studied for AGIP Office Building in Italy)

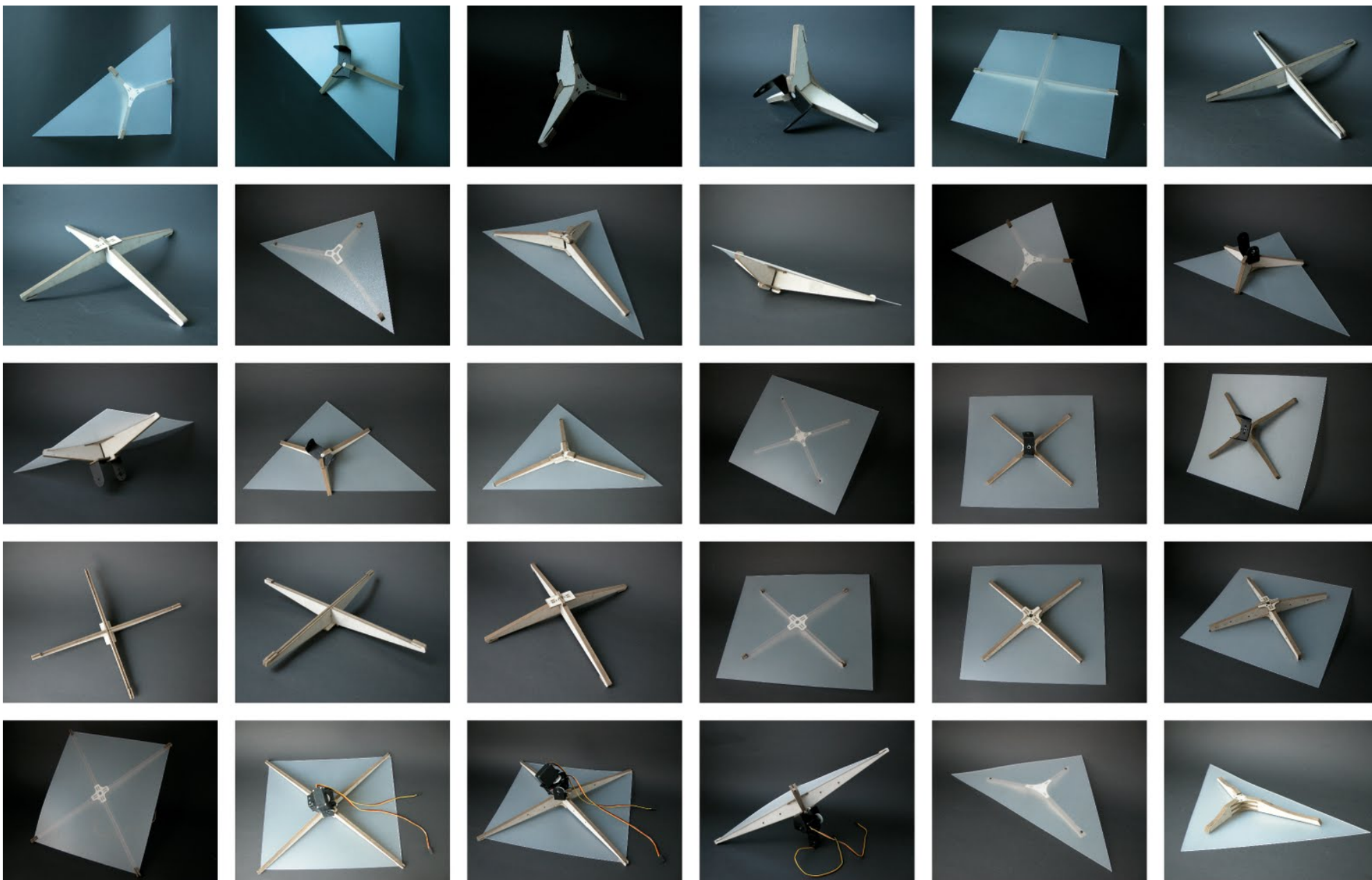


UNIVERSITÀ  
DEGLI STUDI  
FIRENZE  
Scuola di  
Architettura



INTERNATIONAL COURSE ON  
ARCHITECTURAL DESIGN

# SOLAR & LIGHT CONTROL- ADAPTIVE SCREEN



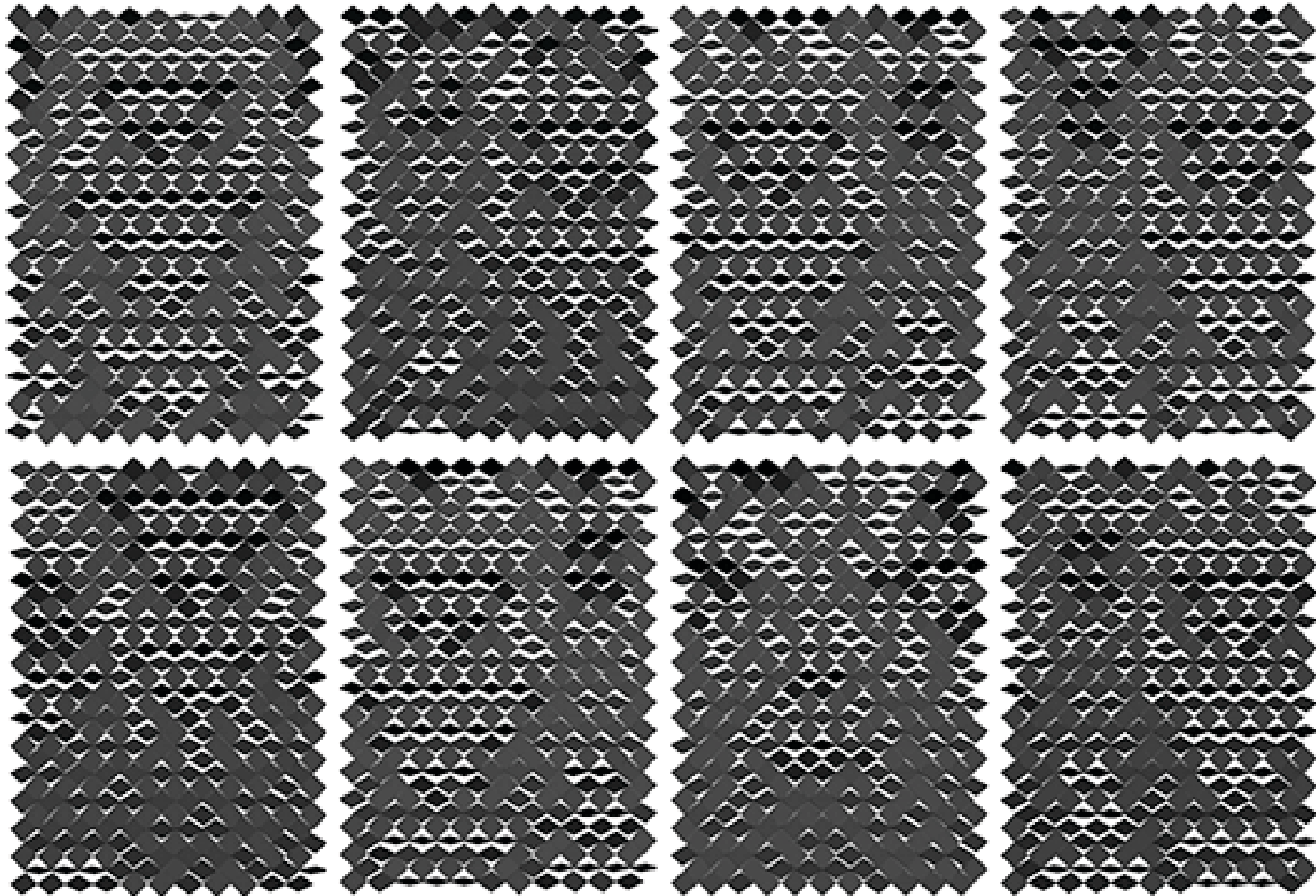


UNIVERSITÀ  
DEGLI STUDI  
FIRENZE  
Scuola di  
Architettura

**iCAD**

INTERNATIONAL COURSE ON  
ARCHITECTURAL DESIGN

# SOLAR & LIGHT CONTROL- ADAPTIVE SCREEN





UNIVERSITÀ  
DEGLI STUDI  
FIRENZE  
Scuola di  
Architettura

**iCAD**

INTERNATIONAL COURSE ON  
ARCHITECTURAL DESIGN

# SOLAR & LIGHT CONTROL- ADAPTIVE SCREEN





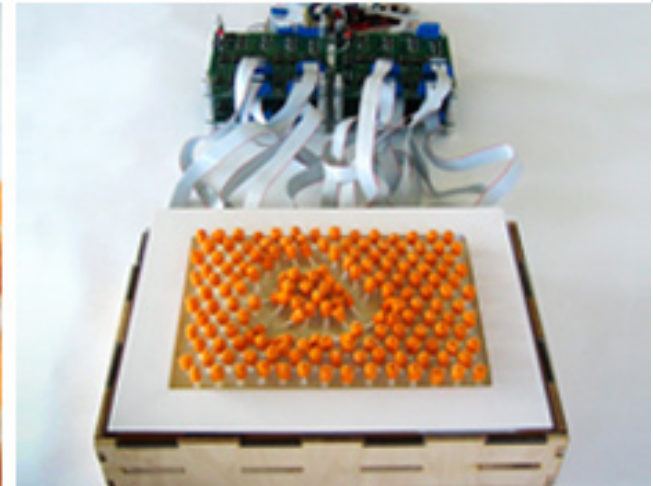
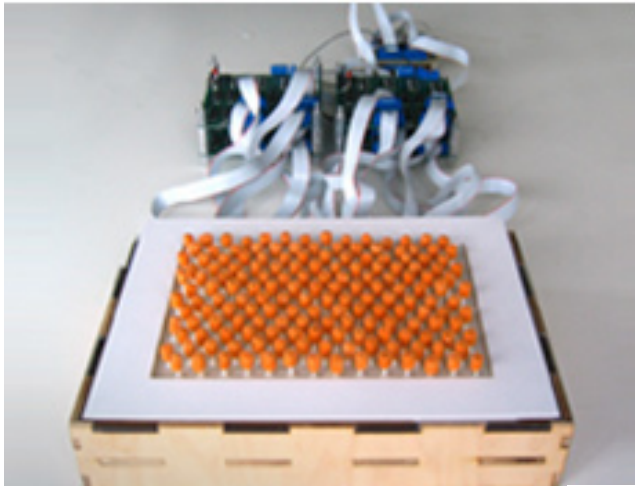


Green walled facade Kengo  
Kuma

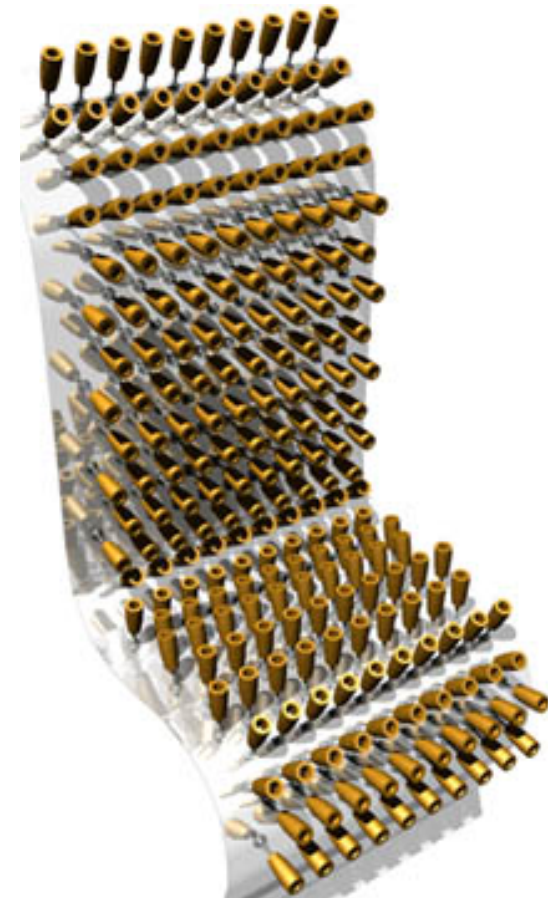
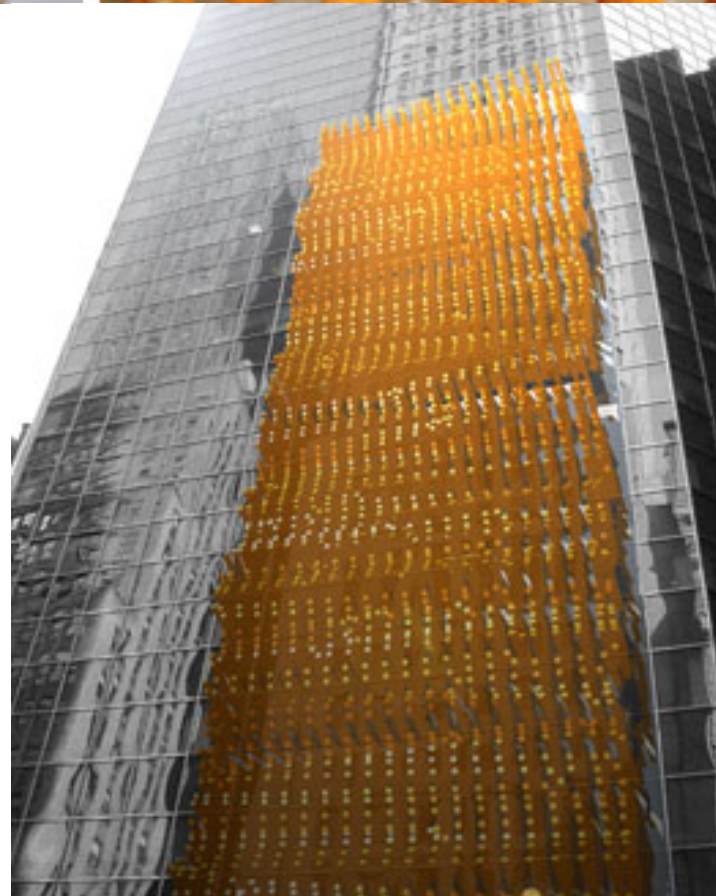
Designed by architects Kengo  
Kuma & Associates, the  
building's slightly slanted  
panels are formed over  
decaying styrene foam,  
creating organic-looking  
vertical planters over the  
structure's entire surface.



Plants pop through small holes of the die-cast  
aluminum panels that punctuate the living facade of  
Green Cast, a mixed-use building in Odawara, Japan.



SUPERCILIA



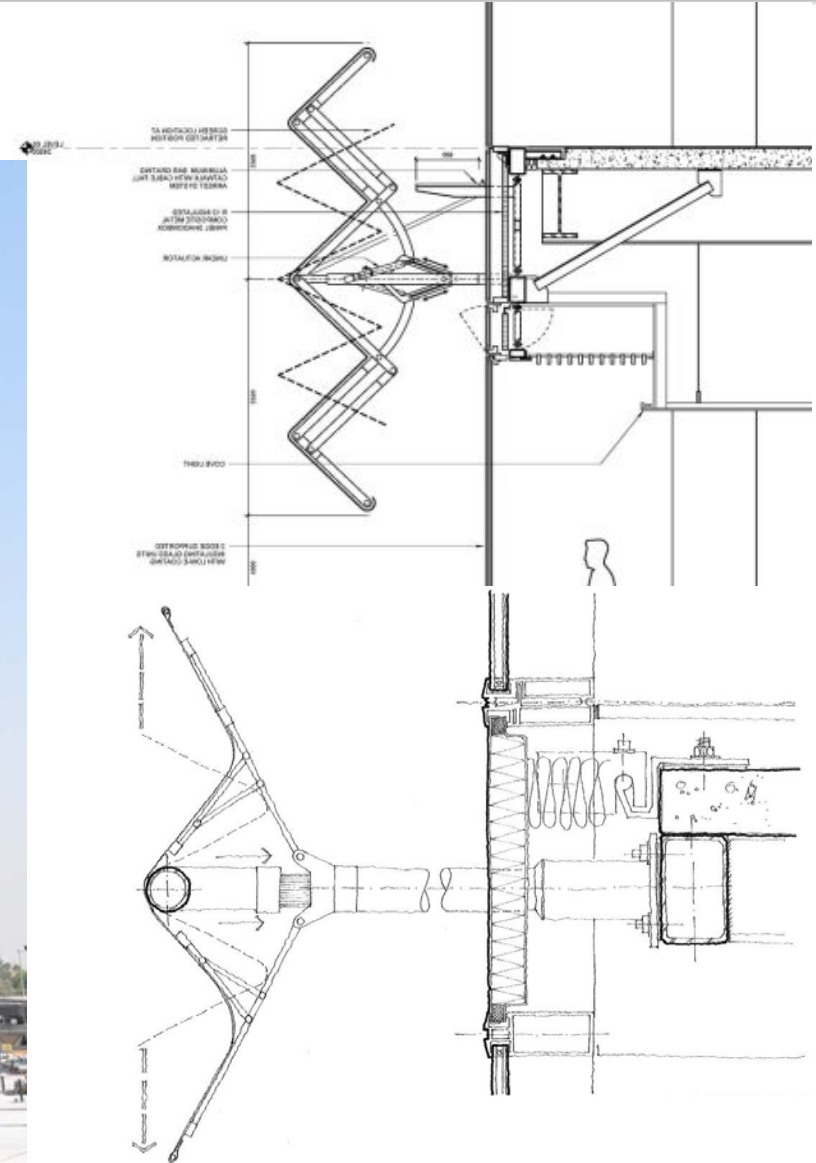


UNIVERSITÀ  
DEGLI STUDI  
FIRENZE  
Scuola di  
Architettura



INTERNATIONAL COURSE ON  
ARCHITECTURAL DESIGN

# SOLAR & LIGHT CONTROL- ADAPTIVE SCREEN



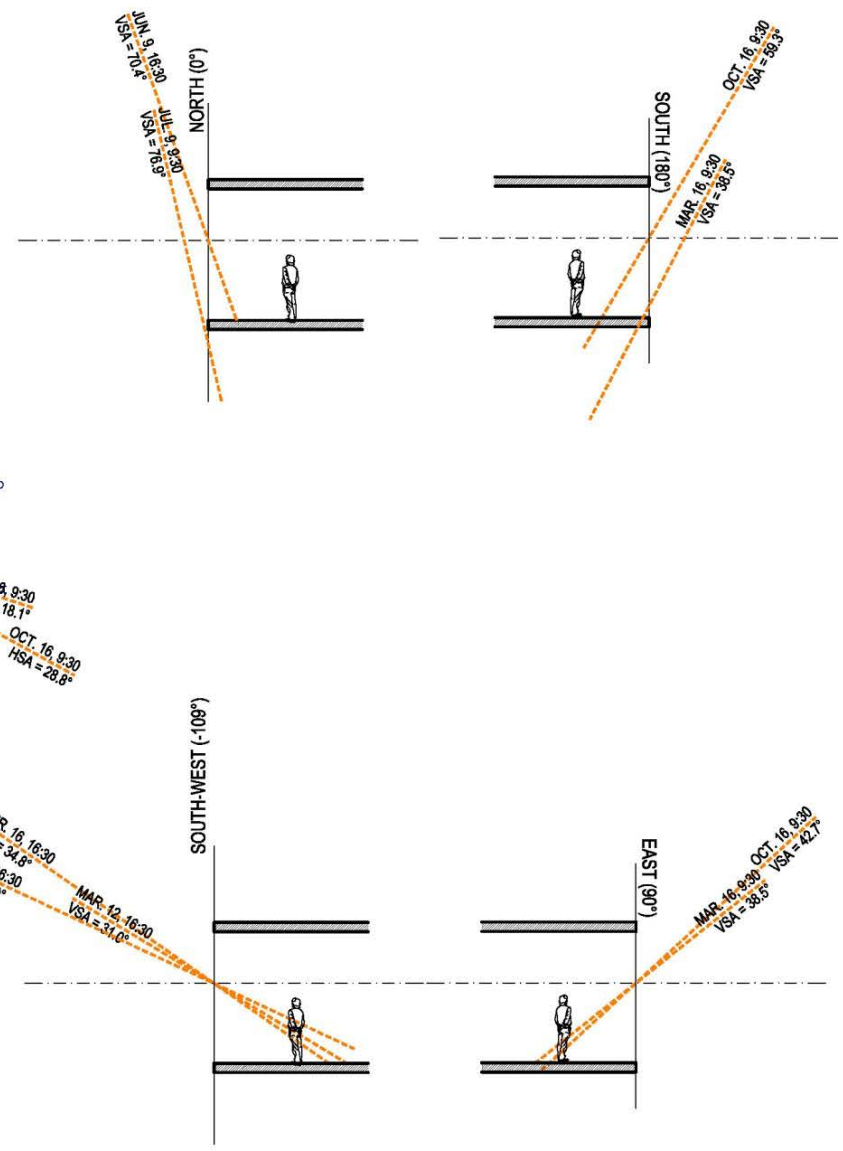
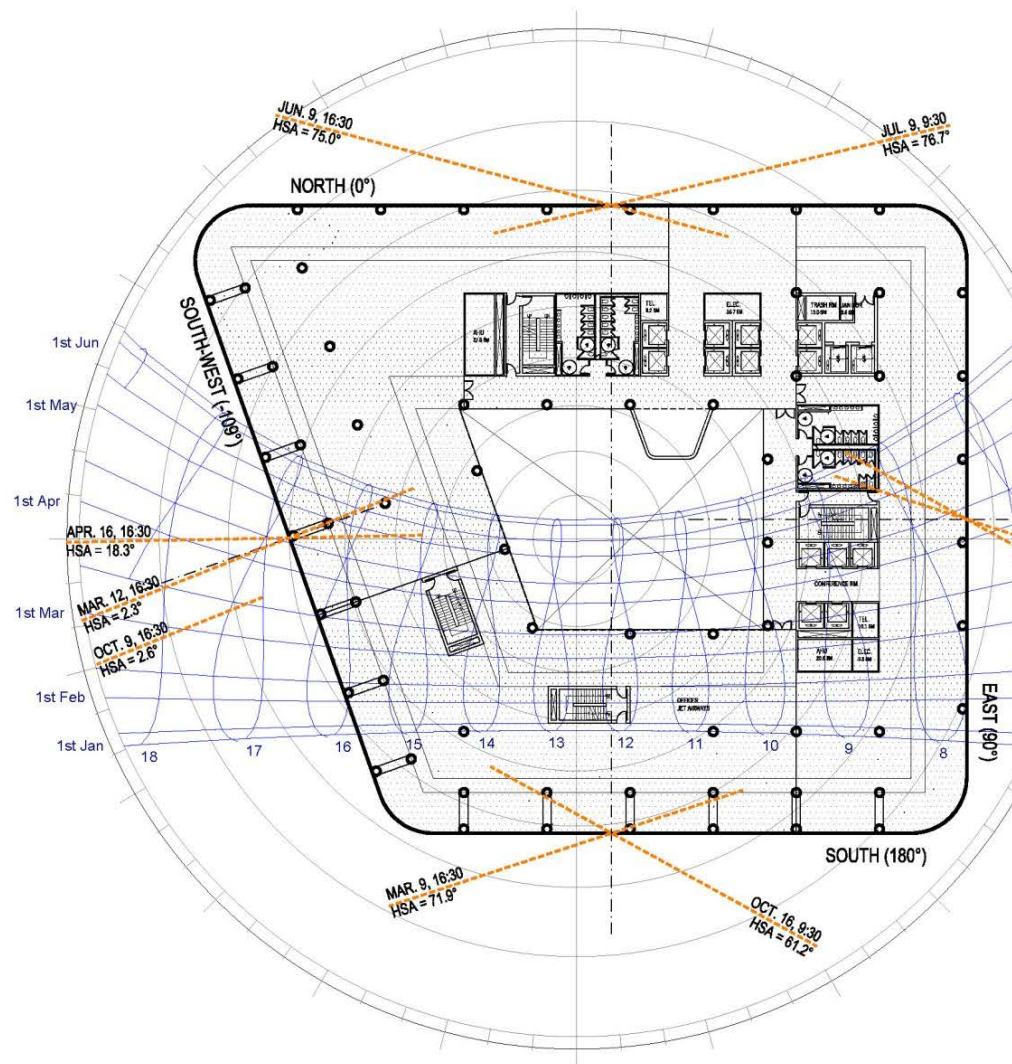
Tongji University Team, “Para Eco House” combines both parametric and ecological strategies. A combination of Dao theory in eastern philosophy and the theories of Michel Foucault in western thought, especially the ideas of autonomy in architecture.

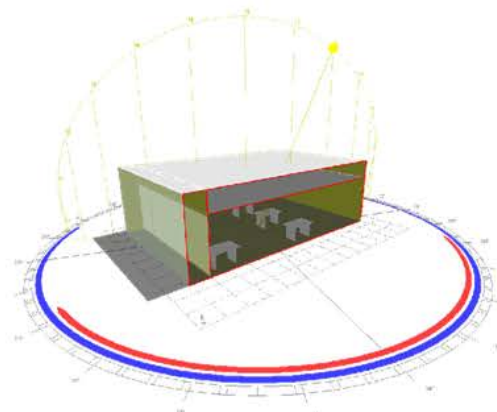
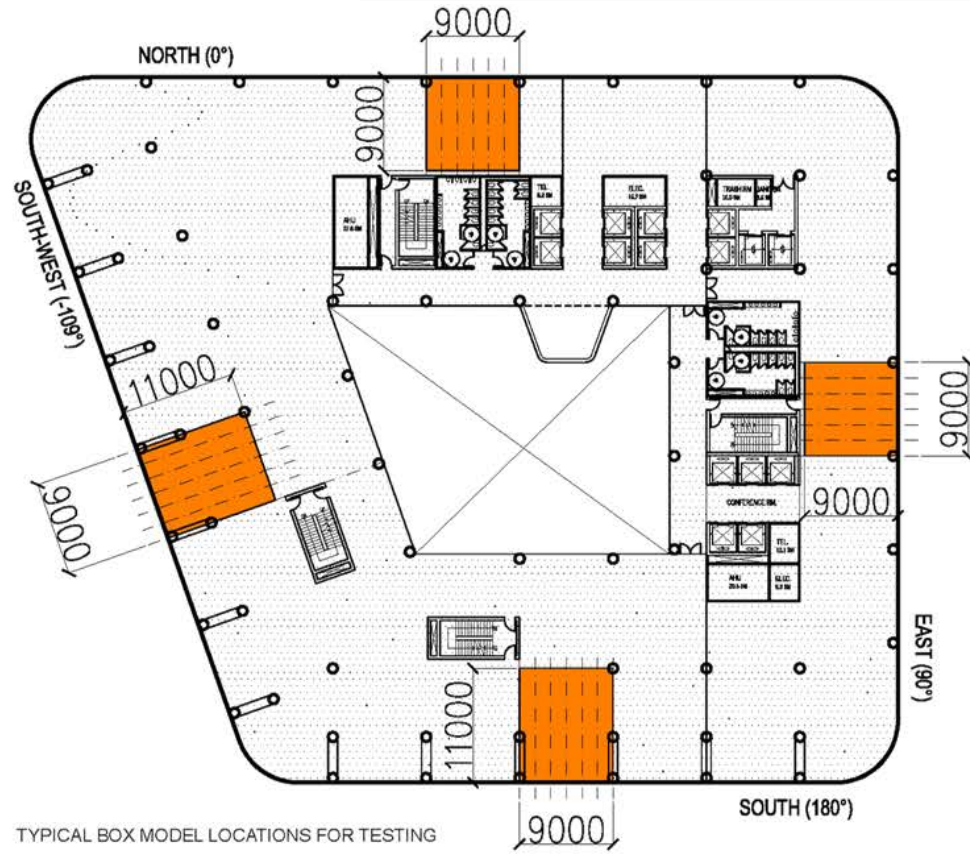
- The roof components include solar tracking PV panels and shading system.
- The west elevation of the house combines thin film solar cells and vertical greenery. The size of the holes varies due to the wind pressure on the elevation which enriches the semi-open space creating an eco-transition between nature and interior space.
- The wetland water system under the open deck plays an important role in enhancing the environmental quality
- The mist spraying system creates comfortable and pleasing atmosphere for various events as well as helping cool the wind blowing through the living area.



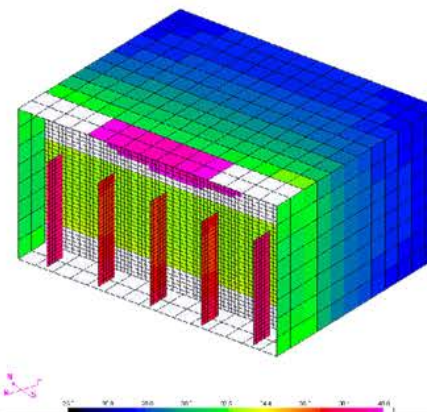


# EXAMPLE





TYPICAL BOX MODEL FOR DAYLIGHTING (ECOTECT)



TYPICAL BOX MODEL FOR SOLAR LOADS (RAD-THERM)



UNIVERSITÀ  
DEGLI STUDI  
FIRENZE  
Scuola di  
Architettura



INTERNATIONAL COURSE ON  
ARCHITECTURAL DESIGN

# EXAMPLE

## Radtherm Thermal Analysis Software

RadTherm - jet airway-west.tdf

File Edit View Tools Units Window Help

Part Element Magnify N-sided Trans-note RotateX Rot-YZ Zoom Hide Hide Uns Show Inv Hide Assign SI C mm SI K m ENG F in Reset Lost Center Desc +X +Y +Z -X -Y -Z

Geometry Editor Analyze Post Process

Current Time: Mar 28, 1990 15:00:00

Resume Speed: +

Results Environment Plot/Export Notes

Part 19 Part Type: Transparent

Average Temperature (°C)

Front	40.5225	<input checked="" type="radio"/> Display Heat Rates/BCs
Back	40.5225	<input type="radio"/> Display Heat Rates/BCs

Heat Rates Boundary Conditions

Display as Flux

Heat Rate Flux (W/m²)

	Incident	Outgoing	Net
Q Conduction			0.00107125
Q Convection	0	11.1884	-11.1884
Q Radiation	549.198 *	548.969 *	0.229187
Q Solar			25.7259
Q Imposed			0

Model size (mm):  
X = 9044.8  
Y = 8114.87  
Z = 3900

Mar 28, 1990 15:00:00

25.0 26.9 28.8 30.6 32.5 34.4 36.3 38.1 40.0

Min Temperature (°C) Display Scale Auto Scale Max Temperature (°C)

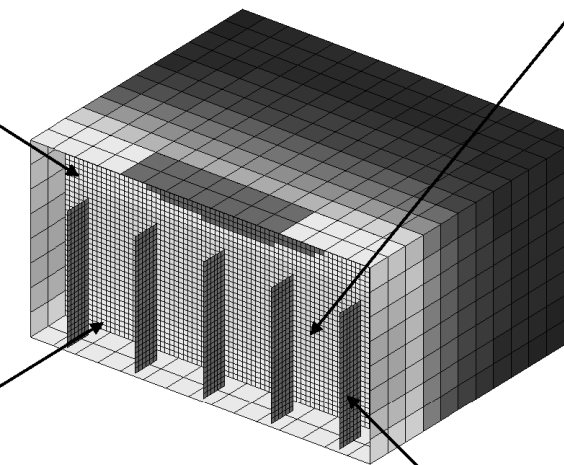
25 40

1) This TDF file was written with RadTherm 9.0.1  
2) Model statistics: Elements: 10257 Parts: 19  
3) Thermal results data was written by version 9.0.1

## Surface physical properties of modeled double wall glazing system

Upper spandrel pane: polished aluminum  
Absorptivity=0.08  
Emissivity=0.05

Lower spandrel panel: polished aluminum  
Absorptivity=0.08  
Emissivity=0.05



### Parameters of glazing system

#### 1) External double pane glazing

Outer layer: VE 2-2M with 6mm thickness

$E_{out}=0.84$ ,  $E_{in}=0.04$

Reflectance=0.05

Transmittance=0.28

Air-gap: 13 mm thickness

Inner layer: clear glass with 3mm thickness

$E_{out}=0.84$ ,  $E_{in}=0.84$

Reflectance=0.08,

Transmittance=0.76

#### 2) Internal single pane glazing

Clear glass with 3 mm thickness

$E_{out}=0.84$ ,  $E_{in}=0.84$

Reflectance=0.08

Transmittance=0.76

### Metal fin

North surface: polished aluminum

Absorptivity=0.08

Emissivity=0.05

South surface: galvanized aluminum

Absorptivity=0.49

Emissivity=0.22

Internal glazing surface solar heat flux

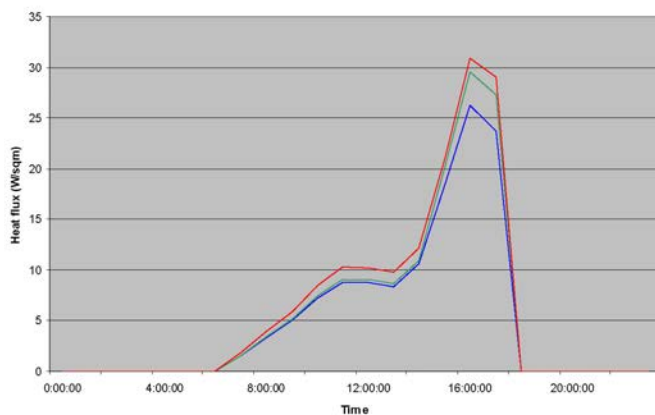


Figure. Surface physical properties of modeled double wall glazing system

— Angel 30  
— Angel 0  
— no fin

Fin distance = 1500 mm

Fin width = 600 mm

Fin shade can reduce solar radiation penetrating into the building space.

Comparison in the Figure above shows that the peak solar radiation heat flux can be reduced by 1.3~4.7 W/sqm of window area. Fins with angle of 30 degree give the largest solar heat flux reduction.





UNIVERSITÀ  
DEGLI STUDI  
FIRENZE  
Scuola di  
Architettura



INTERNATIONAL COURSE ON  
ARCHITECTURAL DESIGN

## EXAMPLE: FEDERAL BUILDING (SFO)

PERFORATED STAINLESS  
STEEL SCREEN

DIAPHANOUS VEIL

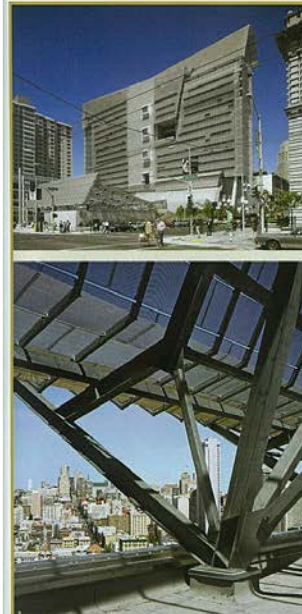
At 240 feet tall, the San Francisco Federal Building can be seen from many parts of the city (opposite). The perforated-stainless-steel scrim that shades its southeast facade pulls away from the base of the tower and is at once diaphanous veil and sharp-edged protective shell.



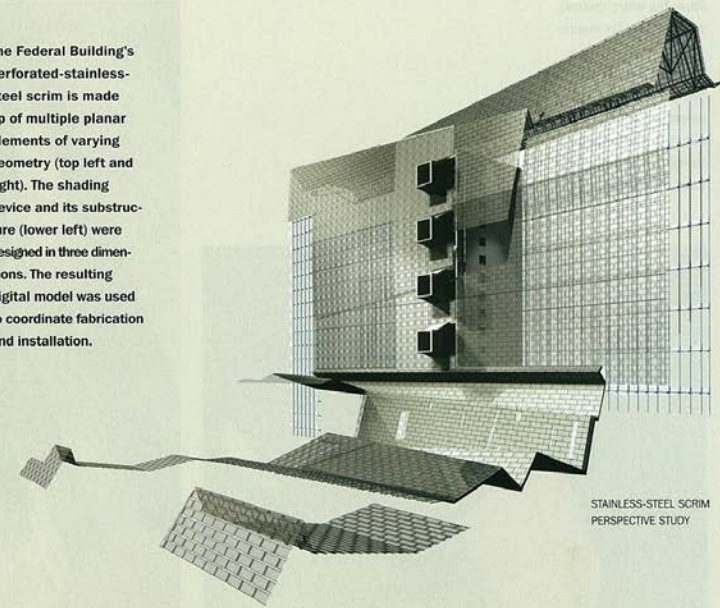
# EXAMPLE: FEDERAL BUILDING (SFO)

A tower shaped by performance objectives and design process

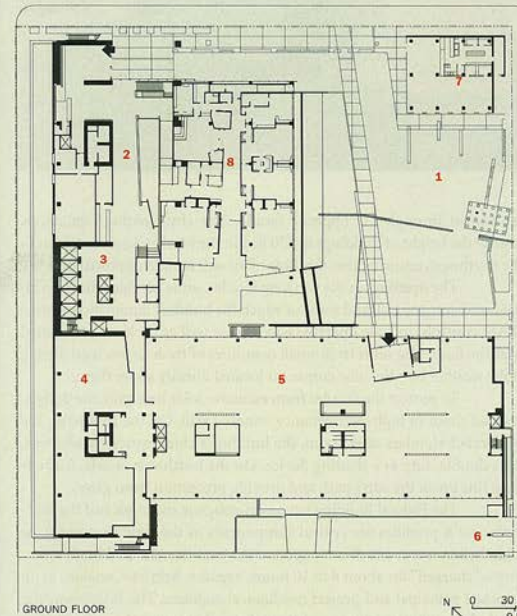
The form, structure, and orientation of the Federal Building office tower are the product of weather-data analysis, wind-speed studies, and air-flow modeling, and an integrated design process. Office floors are long and narrow to provide views and promote day-lighting. The slender floor plate permits breezes to enter through openings on the tower's windward elevation and allows venting through the opposite facade. The building's exposed-concrete slabs are supported by an upturned beam system and have a wave profile in section. The configuration maximizes structural efficiency while increasing surface area, enhancing the slab's ability to absorb heat generated by people, computers, and lights.



The Federal Building's perforated-stainless-steel scrim is made up of multiple planar elements of varying geometry (top left and right). The shading device and its substructure (lower left) were designed in three dimensions. The resulting digital model was used to coordinate fabrication and installation.



STAINLESS-STEEL SCRIM  
PERSPECTIVE STUDY



GROUND FLOOR



TOWER PLAN-LEVEL NINE

- |                      |                           |
|----------------------|---------------------------|
| 1. Plaza             | 6. Parking/loading access |
| 2. Tower lobby       | 7. Café                   |
| 3. Elevator lobby    | 8. Day care               |
| 4. Storage and m/e/p | 9. Office space           |
| 5. Annex             |                           |





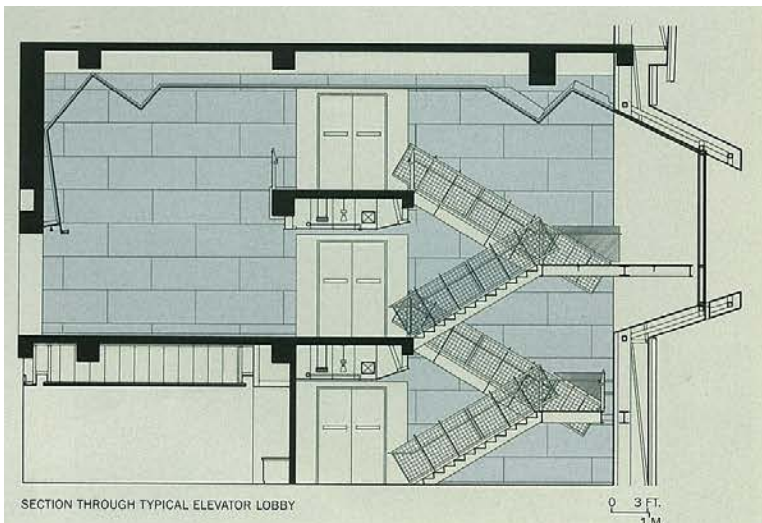
UNIVERSITÀ  
DEGLI STUDI  
FIRENZE  
Scuola di  
Architettura



INTERNATIONAL COURSE ON  
ARCHITECTURAL DESIGN

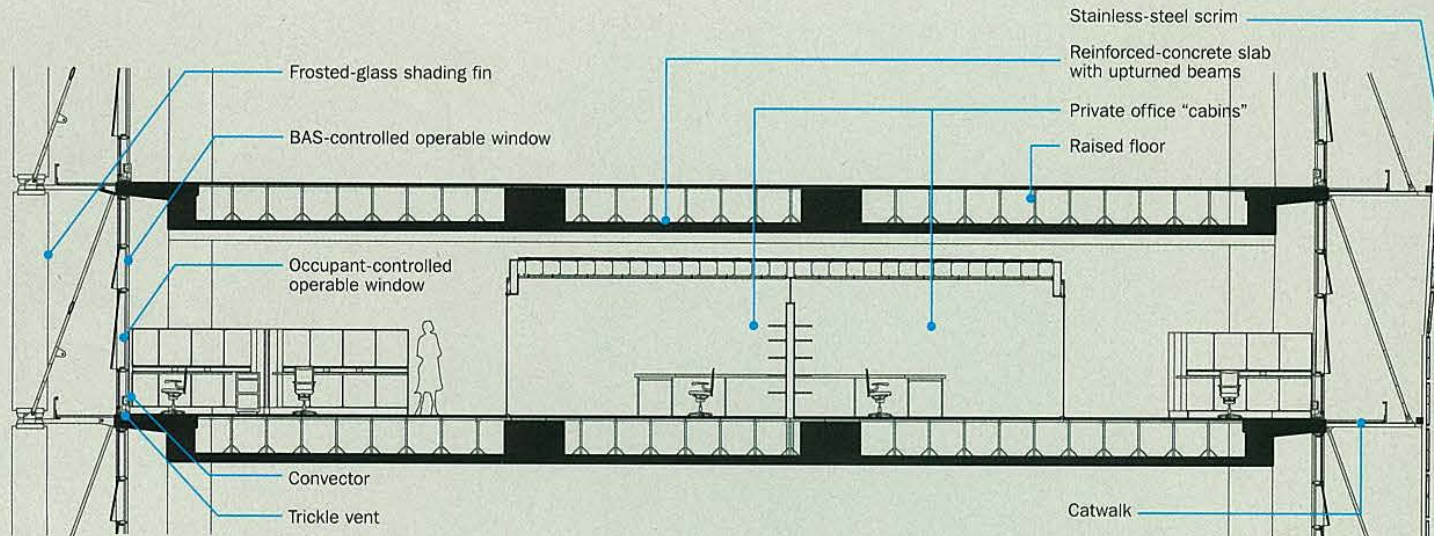
# EXAMPLE: FEDERAL BUILDING (SFO)

Three-story lobbies (right) are a by-product of the skip-stop elevator system first pioneered by Le Corbusier. Projecting stair landings afford views of the city (opposite, bottom).



The frosted-glass fins on the northwest elevation (this page) are separated from the window wall with a catwalk. Zoning regulations limit the height of adjacent buildings to 120 feet, ensuring that the flow of air through this facade will not be obstructed. The sky garden's suspended walkways (opposite) have fritted-glass balustrades and incorporate seating.

# EXAMPLE: FEDERAL BUILDING (SFO)

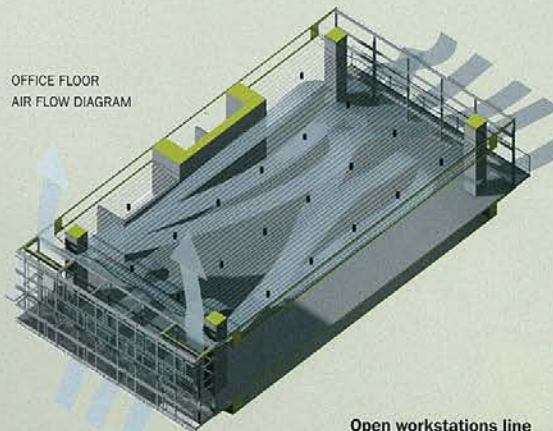


SECTION DETAIL THROUGH TYPICAL OFFICE FLOOR

0 3 FT.  
1 M.

The designers protected the tower's facades from heat gain with a shading scrim on the south-east elevation and frosted-glass fins on the northwest. Some of the openings in these window walls are controlled by the occupants and some by the building automation system.

OFFICE FLOOR  
AIR FLOW DIAGRAM

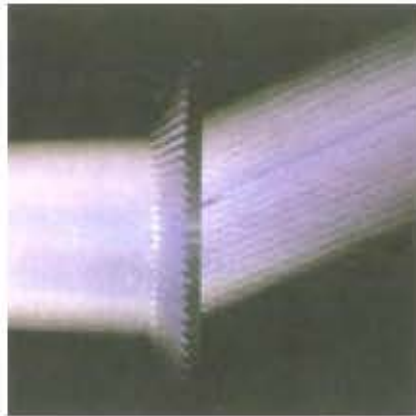


Open workstations line



Open workstations line the perimeter of the office floors while glass-enclosed meeting rooms and office "cabins" occupy the building's spine (right).

# EXAMPLE: CNA – SUVA BUILDING



## CNA-SUVA Building

Building: CNA-SUVA Building

Location: Basel, Switzerland

System: Prismatic panel in double envelope system

Architect: Herzog and DeMeuron

Renovation Completion: 1993

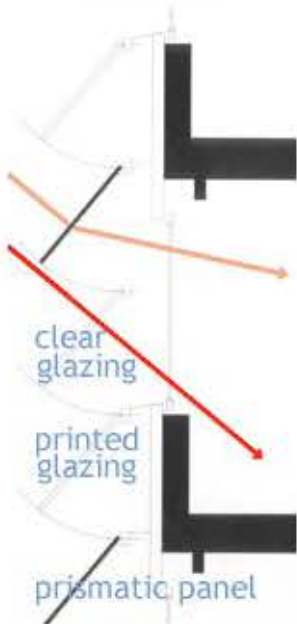
Project Description: The renovation of a low-rise office building in Switzerland by the addition of exterior layer of prismatic panels.

The double-skin facade reduces heat losses in the winter and heat gain in the summer through optical control of sunlight. Within one floor height, the double-skin facade can be divided into three sections. The upper section is made of insulating glass with integrated prismatic panels which automatically adjusts itself as a function of the altitude of the sun. This panel has two functions: reflecting sunlight toward the outside and admitting daylight into the interior space. The vision window is made of clear insulating glass and is manually operated by the occupant during the daytime. The lower level window is automatically controlled to stay closed when solar and thermal insulation are desired.

### Reference

Fontoynt, M. and European Commission Directorate-General XII Science Research and Development (1999). *Daylight performance of buildings*. London, James & James (Science Publishers) for the European Commission Directorate General XII for Science Research and Development.

PRISMATIC PANEL



Top: The prismatic panel reflects light to the desired angle.

Bottom: Sectional detail of the facade system.





UNIVERSITÀ  
DEGLI STUDI  
DI FIRENZE  
Scuola di  
Architettura

PRISMATIC PANEL

INTERNATIONAL COURSE ON  
ARCHITECTURAL DESIGN

# EXAMPLE: CNA – SUVA BUILDING



dear ginza armano design



UNIVERSITÀ  
DEGLI STUDI  
FIRENZE  
Scuola di  
Architettura



INTERNATIONAL COURSE ON  
ARCHITECTURAL DESIGN

## EXAMPLE: SNØHETTA, DELOITTE OFFICES



Oslo-Norway-

# EXAMPLE: SNØHETTA, DELOITTE OFFICES

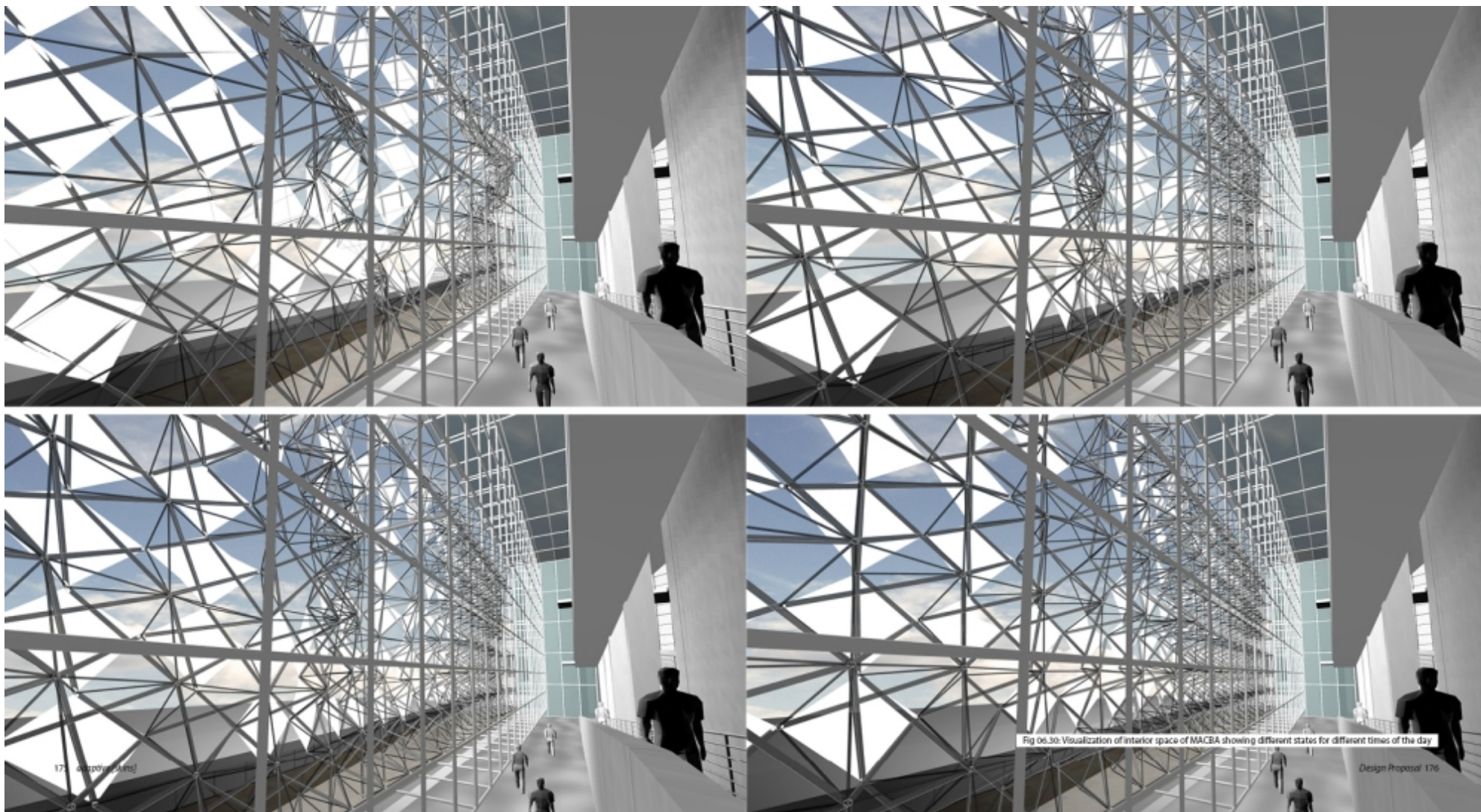
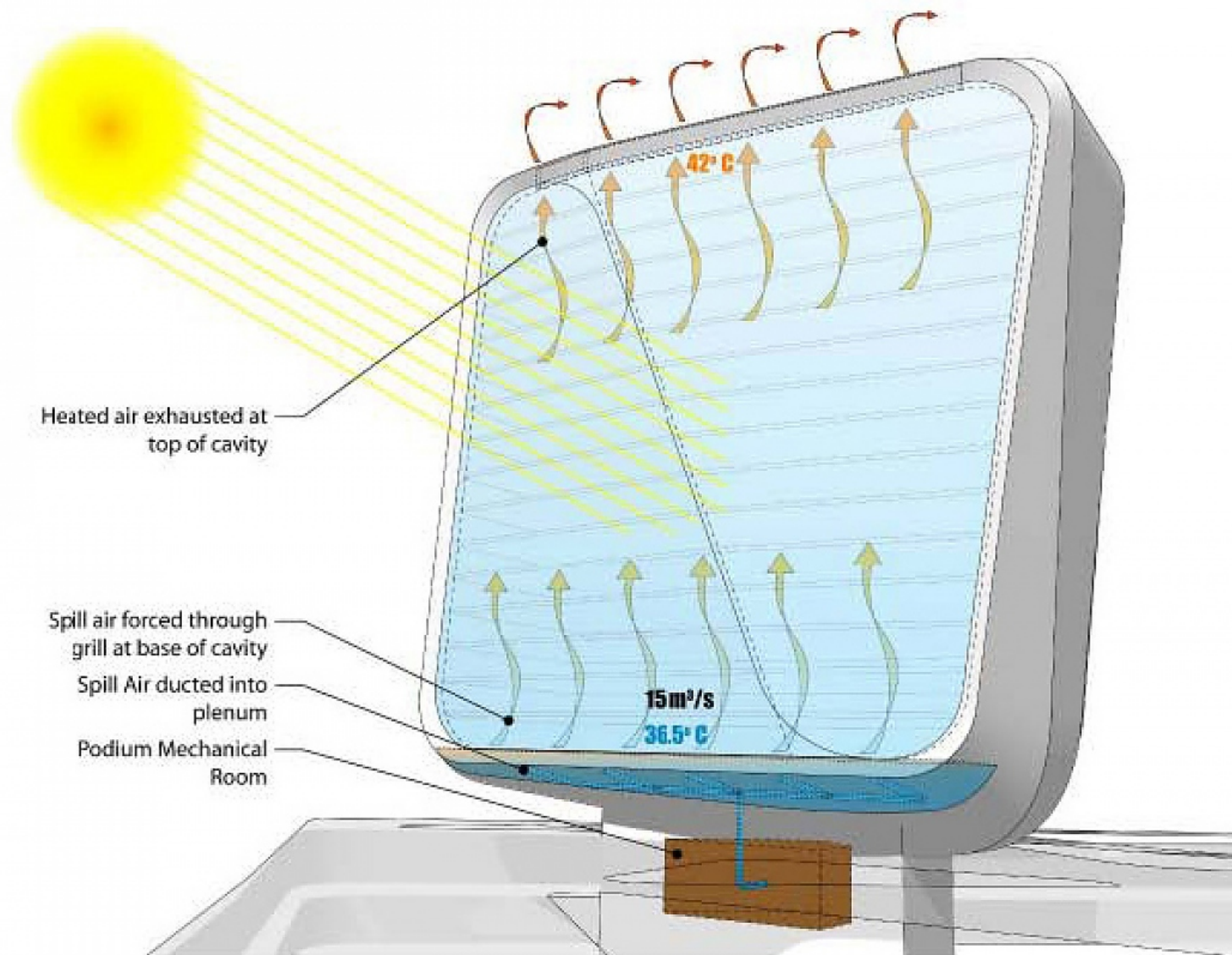
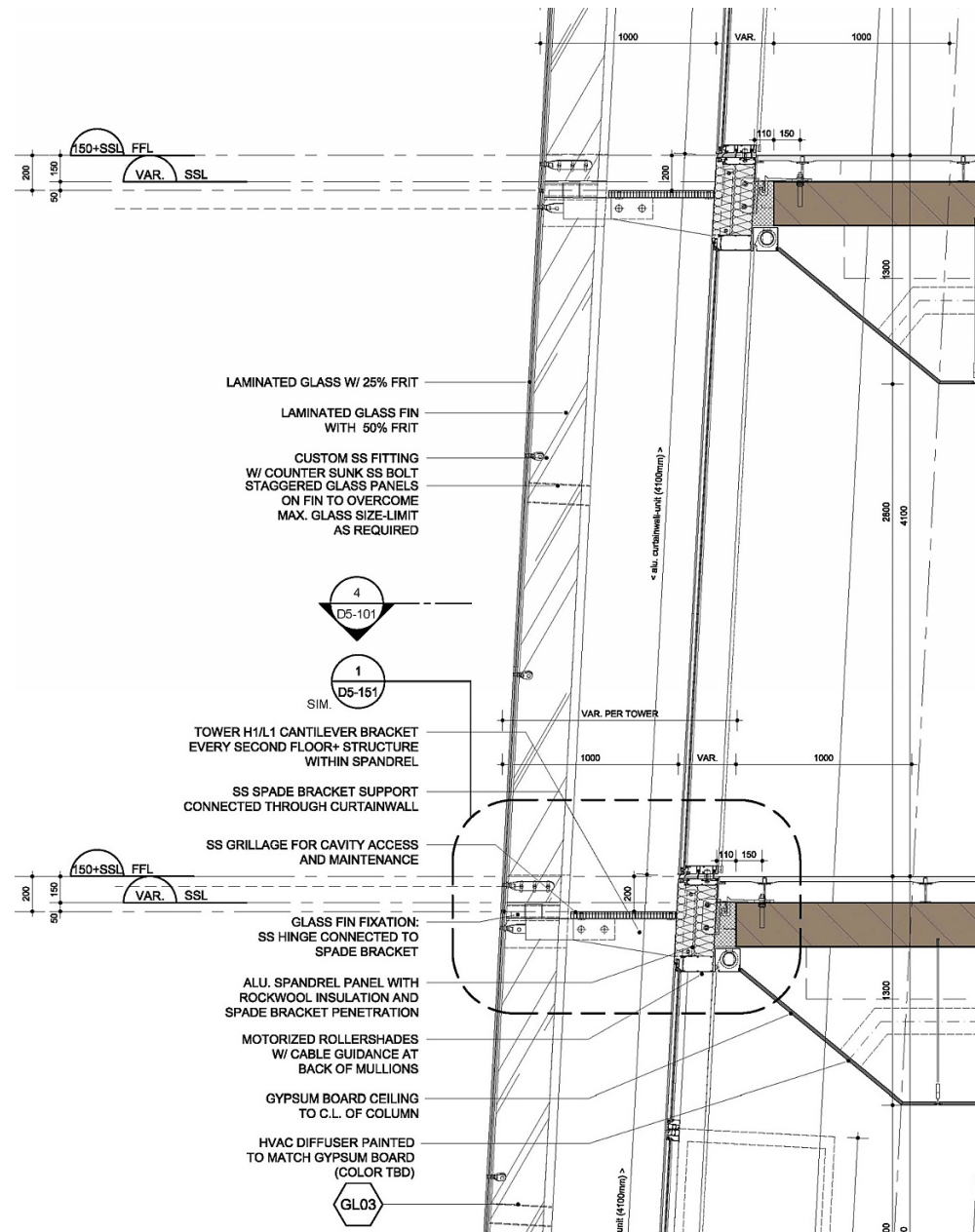


Fig 06.30 Visualization of interior space of MACBA showing different states for different times of the day





UN STUDIO, TWOFOUR54 MEDIA ZONE 1, Abu Dhabi 2009



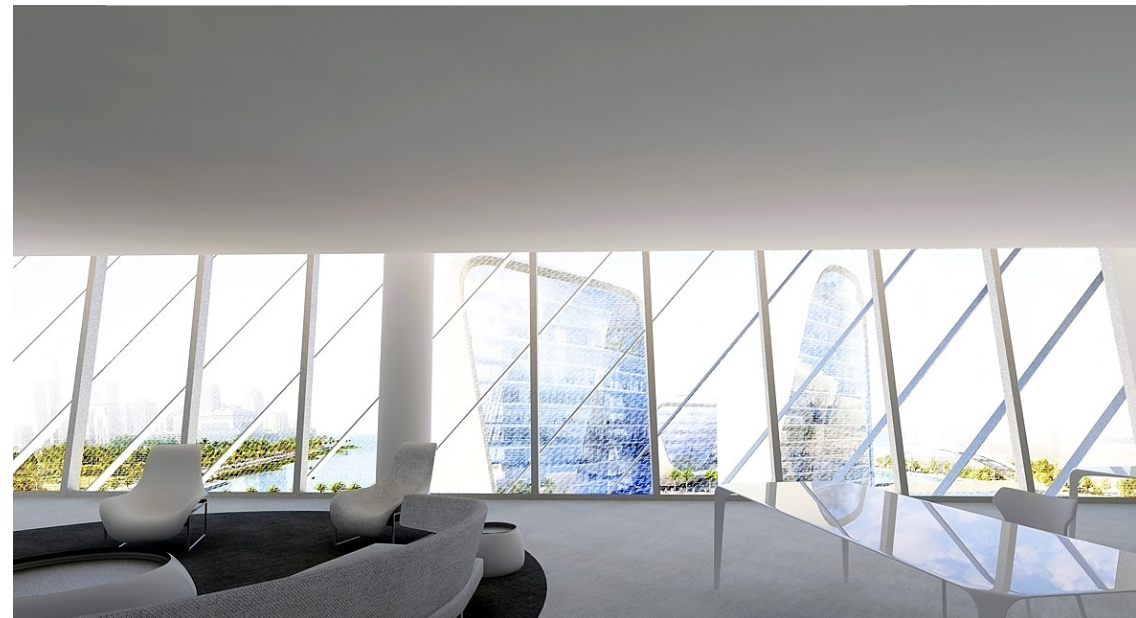
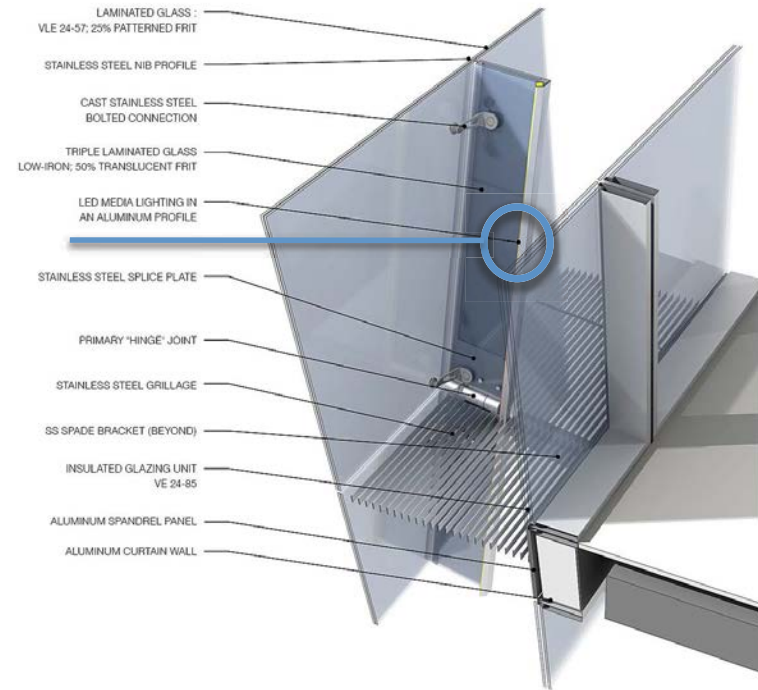
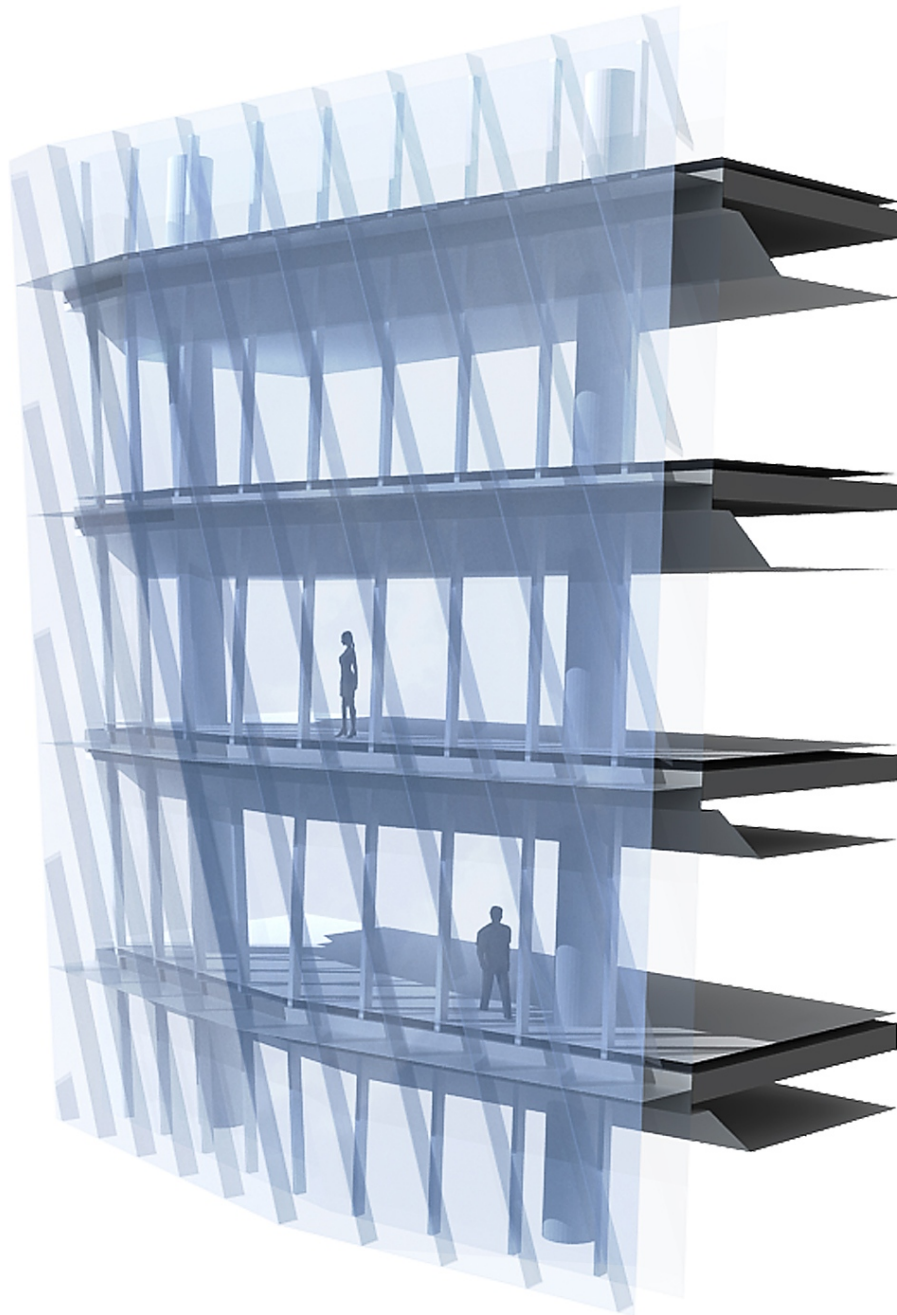


UNIVERSITÀ  
DEGLI STUDI  
FIRENZE  
Scuola di  
Architettura

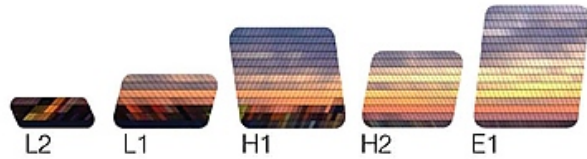


INTERNATIONAL COURSE ON  
ARCHITECTURAL DESIGN

# EXAMPLE: UN STUDIO, TWOFOUR54 MEDIA ZONE



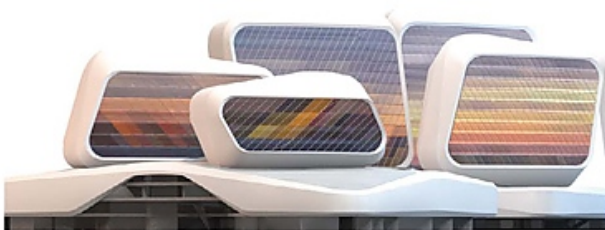
# EXAMPLE: UN STUDIO, TWOFOUR54 MEDIA ZONE



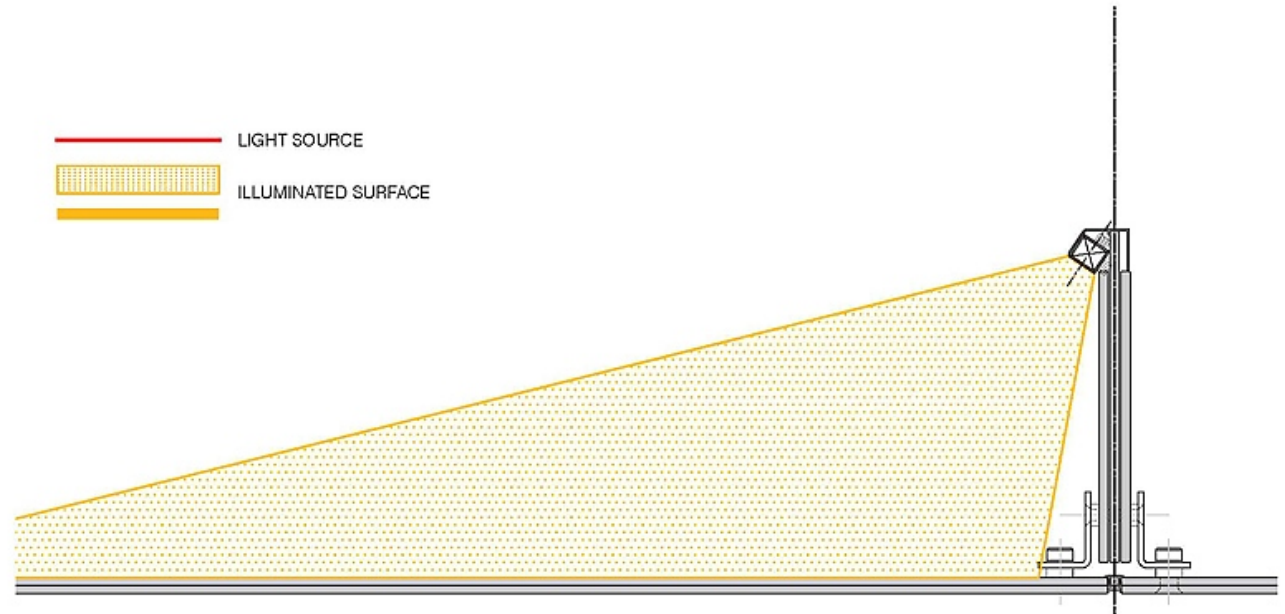
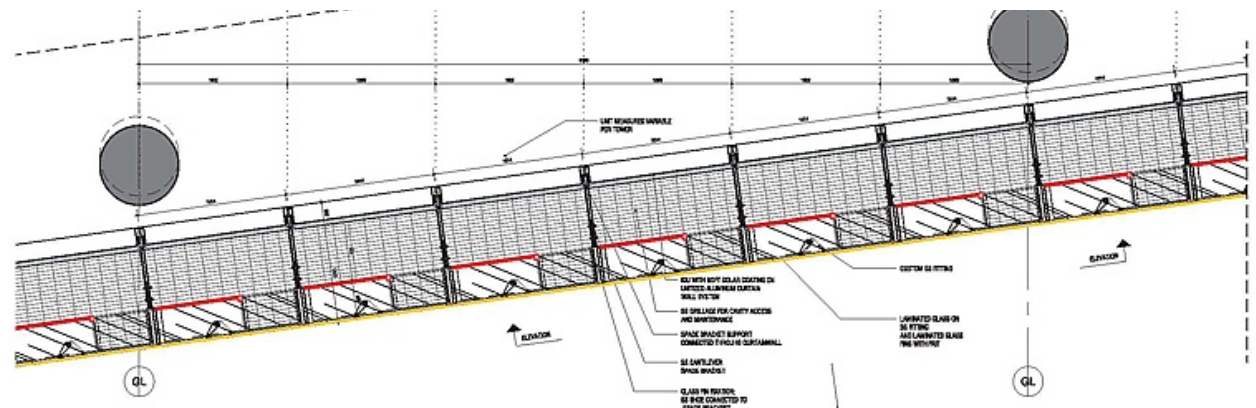
A

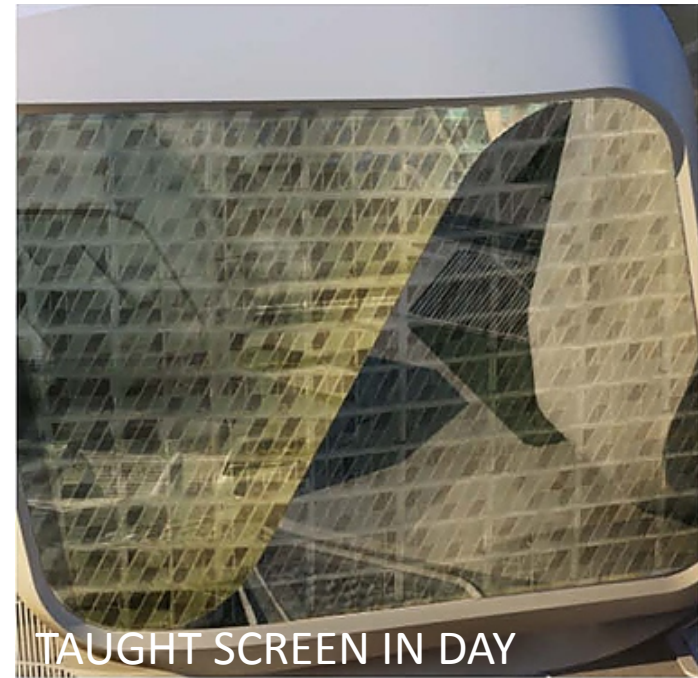


B

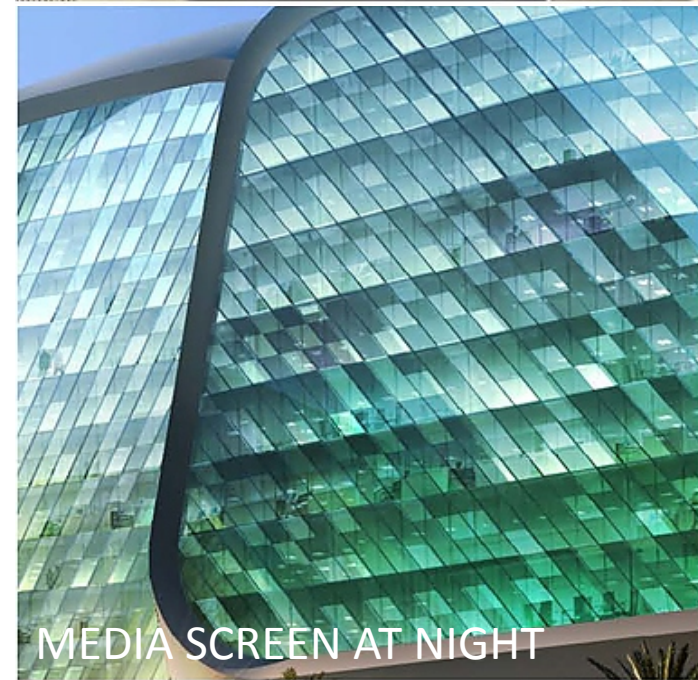


C

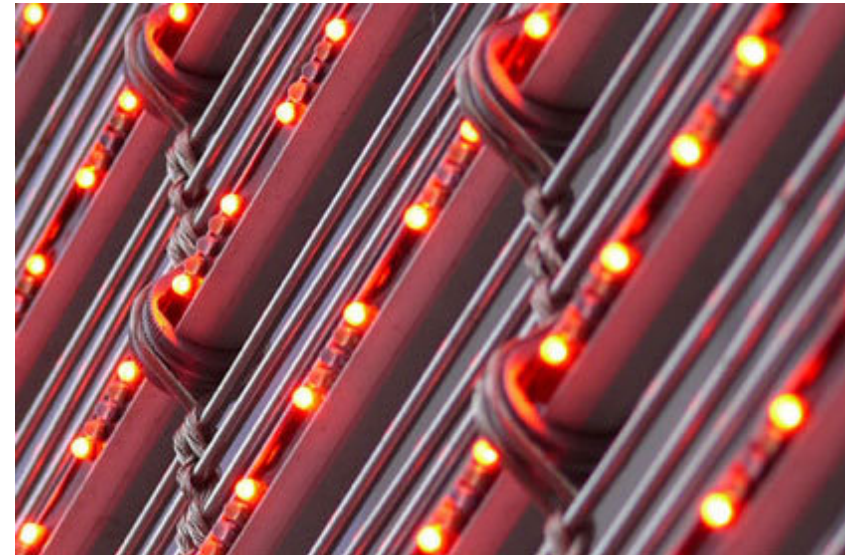
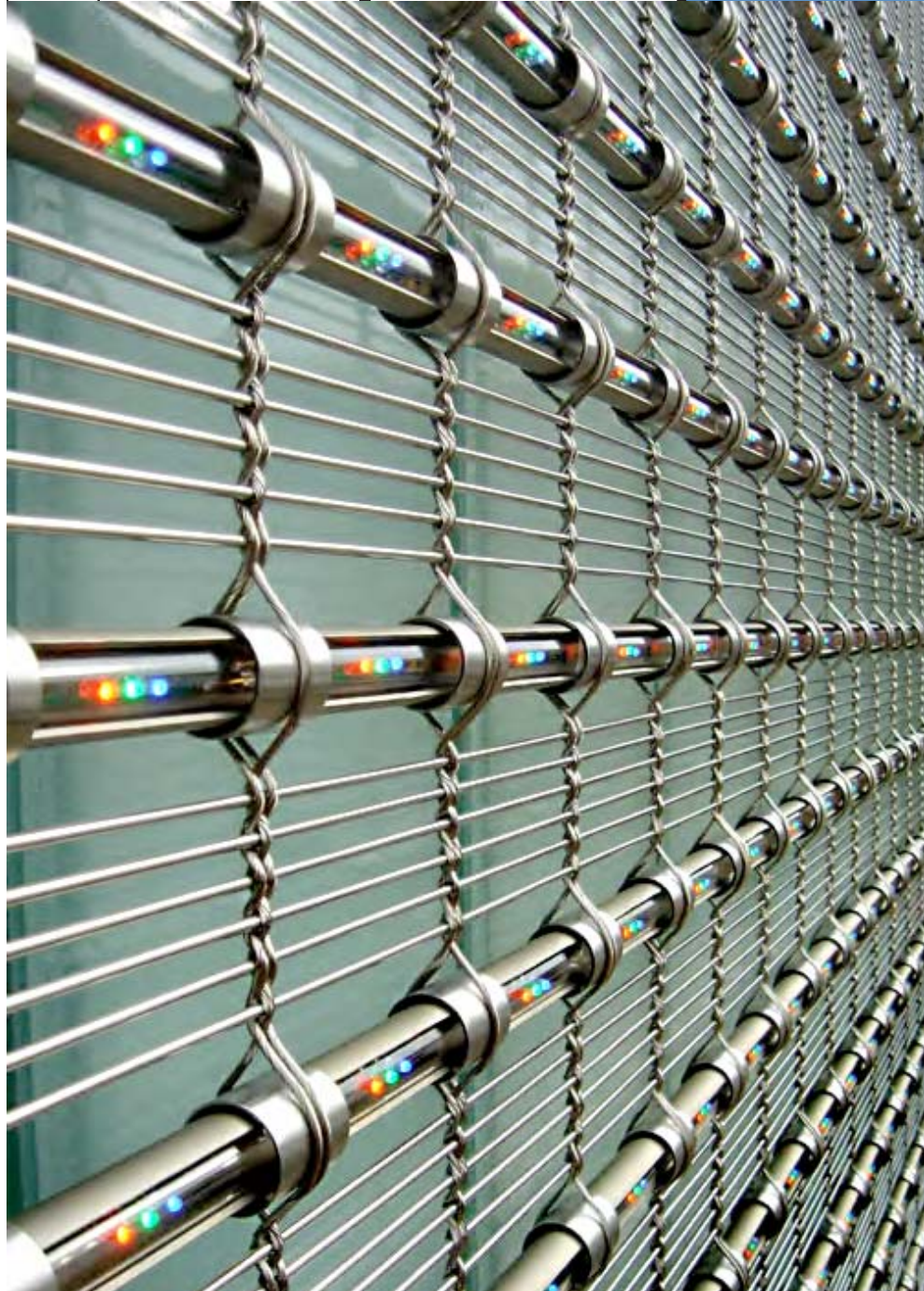




TAUGHT SCREEN IN DAY



MEDIA SCREEN AT NIGHT



Mediamesh is an LED  
video display wire mesh



UNIVERSITA'  
DEGLI STUDI  
FIRENZE  
Scuola di  
Architettura



INTERNATIONAL COURSE ON  
ARCHITECTURAL DESIGN

# SOLAR & LIGHT CONTROL- ADAPTIVE SCREEN





UNIVERSITÀ  
DEGLI STUDI  
FIRENZE  
Scuola di  
Architettura



INTERNATIONAL COURSE ON  
ARCHITECTURAL DESIGN

# SOLAR&LIGHT CONTROL- ADAPTIVE SCREEN



The upcoming 2008 Olympic Games are inspiring some show-stopping buildings and technologies, among them the Greenpix Zero Energy Media Wall by New York based architecture & media firm Simone Giostra & Partners. Visible from up to a kilometer away on one of Beijing's most congested main roads, the 20,000 square foot bright light facade of the Xicui entertainment complex is more than stunning, it's surprisingly strong in its green credentials. The Greenpix Zero Energy Media Wall is the world's largest color LED display, and has a self sustaining energy life-cycle. Harvesting sunlight collected during the day via photovoltaic solar cells, the wall uses stored solar energy to light up the LED's for a spectacular nighttime show.

Read more: [GREENPIX Zero Energy Media Wall Lights up Beijing | Inhabitat - Sustainable Design Innovation, Eco Architecture, Green Building](#)





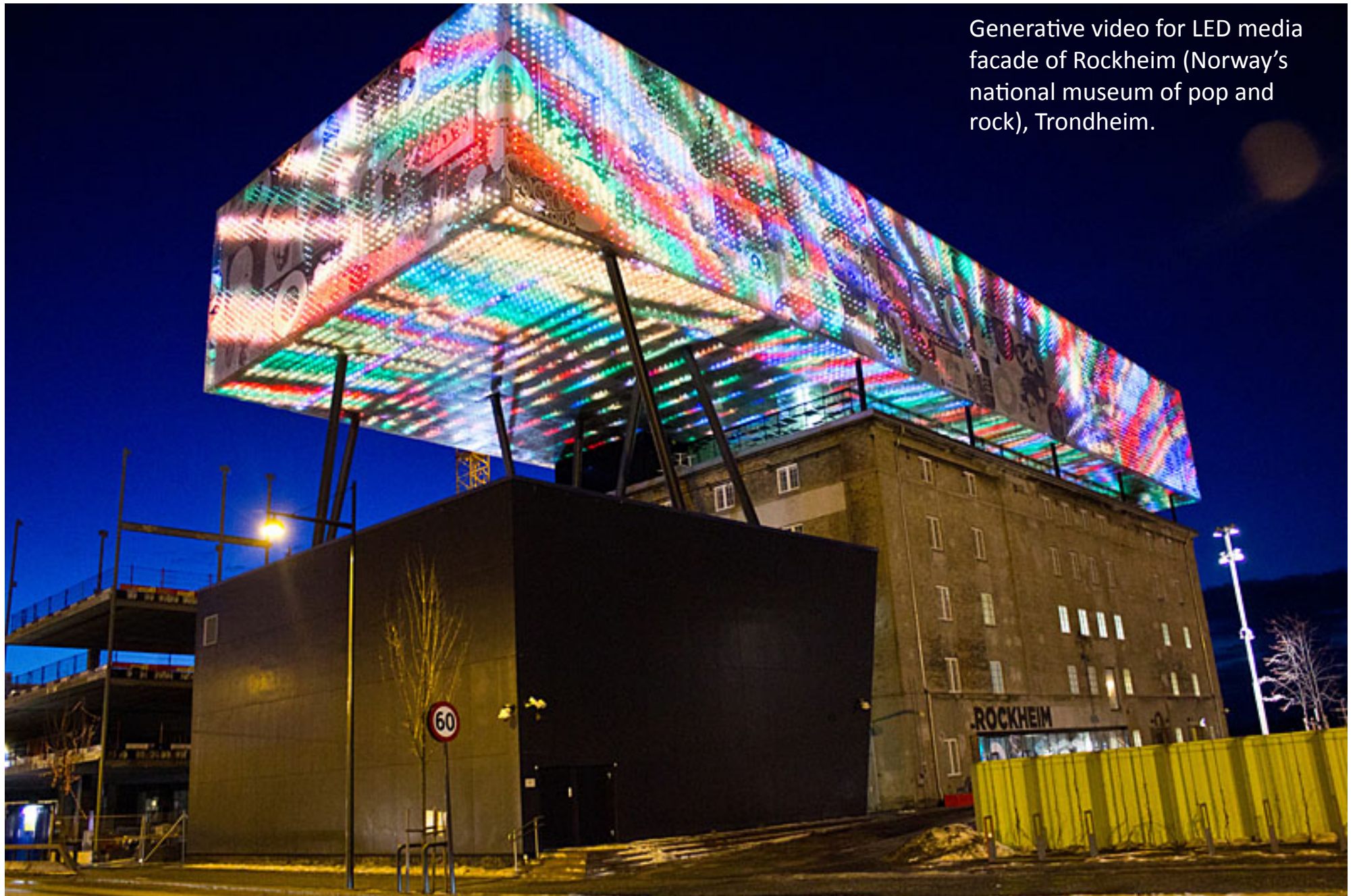
UNIVERSITÀ  
DEGLI STUDI  
FIRENZE  
Scuola di  
Architettura



INTERNATIONAL COURSE ON  
ARCHITECTURAL DESIGN

## EXTERIOR SOLAR CONTROL- MATERIALS

Generative video for LED media facade of Rockheim (Norway's national museum of pop and rock), Trondheim.





P. Cook, C. Fournier, Museum of Modern Arts, Graz, Austria.



## BOOKS, PAPERS AND ONLINE RESOURCES

### High Performance Building Façade Solutions

<http://gaia.lbl.gov/btech/papers/4583.pdf>

### High Performance Commercial Building Façades

<http://www.energy.ca.gov/2006publications/CEC-500-2006-052/CEC-500-2006-052-AT15.PDF>

<http://gaia.lbl.gov/hpbf/>

### Double Skin Façades for Office Buildings

[http://www.ebd.lth.se/fileadmin/energi\\_byggnadsdesign/images/Publikationer/Bok-EBD-R3-G5\\_alt\\_2\\_Harris.pdf](http://www.ebd.lth.se/fileadmin/energi_byggnadsdesign/images/Publikationer/Bok-EBD-R3-G5_alt_2_Harris.pdf)

### Info and BIM detail on green screen

<http://www.greenscreen.com/home.htm>

### Considerations For Advanced Green Facade Design

[http://www.greenscreen.com/direct/Considerations/AdvancedGreenFacadeDesign\\_CEU\\_F12.pdf](http://www.greenscreen.com/direct/Considerations/AdvancedGreenFacadeDesign_CEU_F12.pdf)

### Development of a Double-Skin Façade for Sustainable

#### Renovation of Old Residential Buildings

<http://www.sustainablehealthybuildings.org/PDF/7TH/KIMGON.pdf>

### The Concept of a Double-Skin Façade

<http://www.fenestrapro.com/seeing-double-part-i-the-concept-of-a-double-skin-facade-2/>

<http://www.fenestrapro.com/seeing-double-part-ii-the-role-of-a-double-skin-facade-energy-consumption/>

### Understanding the General Principles of the Double Skin Façade System

[http://tboake.com/pdf/double\\_facade\\_general.pdf](http://tboake.com/pdf/double_facade_general.pdf)

### Determination of the energy performances of ventilated double facades by the use of simulation integrating the control aspect

<http://www.wtcb.be/activefacades/new/download/Prediction%20of%20thermal%20comfort%20and%20energetic%20behaviour%20of%20VDF%20by%20simulation%20software.dfv2%20-%20final.pdf>

### Involucri vetrati a doppia pelle. Performance e qualità realizzativa.

[http://tis.bz.it/doc-bereiche/bau\\_doc/pdf/evento-facciate-1/Colombari%20min.pdf](http://tis.bz.it/doc-bereiche/bau_doc/pdf/evento-facciate-1/Colombari%20min.pdf)

### Facades, Curtain walls Products Archive

<http://www.archiexpo.com/cat/facades-curtain-walls-L.html>

### FACADE Blogspot

<http://facadesconfidential.blogspot.it>

### Facciata a doppia pelle con le piante

<http://www.iuav.it/SISTEMA-DE/Archivio-d/approfondi/progettare/05-scheda-Stec-VanPaassen.pdf>

### Progetto di residenze con l'utilizzo di sistemi solari passivi e di raffrescamento naturale \_Tesi di laurea

<http://digilander.libero.it/bucchisilvestriarchi/tesihm/index.htm>

## VIDEOS

### World-first...construction of an algae-powered building

<https://www.youtube.com/watch?v=jayIKDNFrt0#t=68>

<https://www.youtube.com/watch?v=ay-cPZZOxxk>

### CO2 Sequestration Using Micro Algae

[https://www.youtube.com/watch?v=wht\\_PGd0vm0](https://www.youtube.com/watch?v=wht_PGd0vm0)

Video green from TU DELF <https://www.youtube.com/watch?v=CgHsZXXxZRE>

### Colour My Thames

<https://www.youtube.com/watch?v=FAMxveWjv2o>

### FLOW System Prototype (Adaptive Textile Facade Concept)

<https://www.youtube.com/watch?v=gsqqSr3QlGA>

### Brisbane airport car park features a kinetic facade to create energy and movement

<https://www.youtube.com/watch?v=sbq6HqqiXcQ>

## VIDEO TUTORIALS

### Parametric Shaded Walkway

<https://www.youtube.com/watch?v=oi6Ng0Csdyo>

## SOFTWARE PLUG IN

### Paratevision

<https://www.facebook.com/notes/gigabidea/parevitism-toolbox-for-revit-2014/635582509819388>